

PROJOY
electric

– *Switch To Safety!* –



User Manual

PEFS-PCY/PCZS-S-180/480-81

CONTENTS

User Manual of Control Box (DC 24V)

1. Scope and General	1
2 Important Safety Precautions	1
3 Introduction	1
4 Installation & Connection	1
5 Technical Specification	4
6 Trouble Shooting	5
7 Aftersales service and warranty	5
8 Contact us	5

1 Scope and General

This manual is applicable to Control Box (DC 24V) Serise product only.

2 Important Safety Precautions

2.1 Disclaimer

PROJOY assumes no responsibility for any loss, in particular for circuit damage, resulting from any violation of the specifications recommended and referred to in this specification. PROJOY assumes no responsibility for the damage of the product caused by the maintenance, improper use, wrong installation or wrong system design of the product by non-designated personnel.

2.2 Safety instructions:

- 1) PEFS is an electrical product which should be installed by qualified people.
- 2) Turn OFF the DC isolator / switch when do maintenance
- 3) Incorrect wiring may cause Control Box got failed.

3 Introduction

Controller with Power Supply

PEFS-PCY-S-180-31

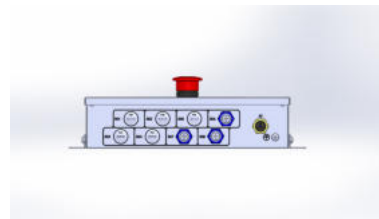
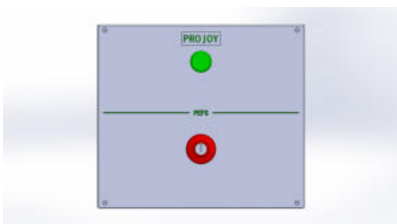

NOTE:DC 6~8 Can be connected externally

PEFS-PCZS-S-480-81

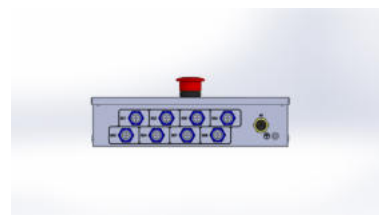
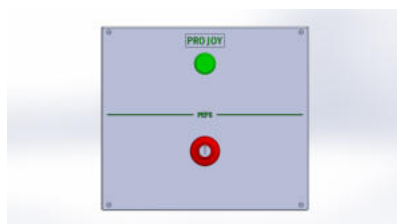

NOTE:DC 1~8 Can be connected externally

4 Installation & Connection

- 1) Open the box, take out Control Box and parts, read this manual.

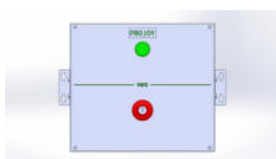

Product



AC Cable

3x18AWG-core wire
1.8m

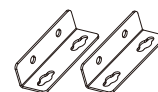

L-shaped Clasps



Manual

2) Prepare materials and tools.



expansion bolt



ST4.8x38

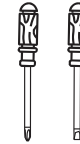

cross/straight screwdriver

3) The installation modes of Control Box are divided into the following two situations.

Controller with Power Supply

a) Mount the controller to the appropriate location through the gourd-shaped hole.

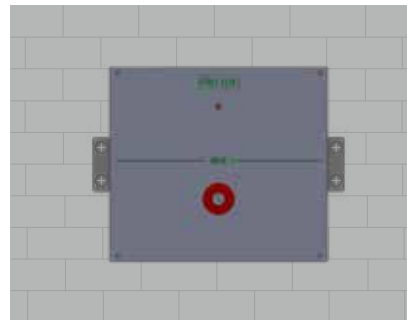

installation location(e.g. wall)

b) Wring of PEFS-PCY/PCZS-S-180-31
AC100-240V Input voltage

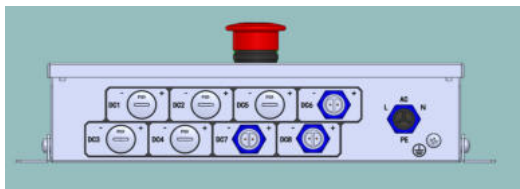

NOTE:DC 6~8 Can be connected externally

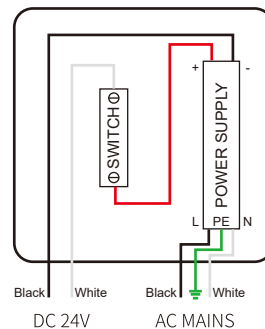

c) Wring of PEFS-PCY/PCZS-S-480-81
AC100-240V Input voltage

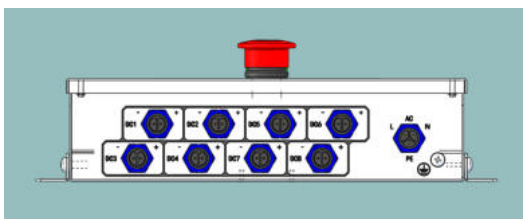

NOTE:DC 1~8 Can be connected externally

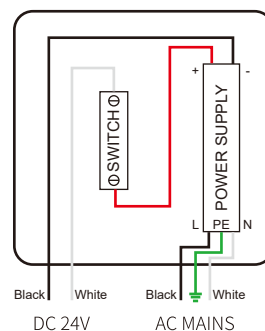

Note: If use extension cable, please make sure the positive (+) and negative (-) poles of 24V cable out of Control Box are aligned with RSD.

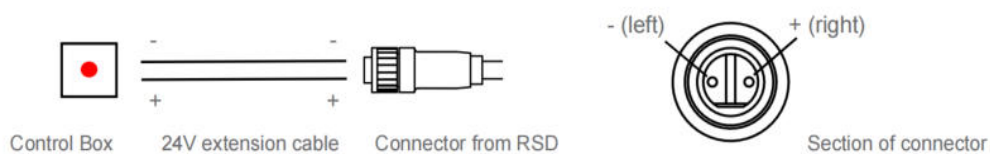

4) Parallel connection of multiple control boxes

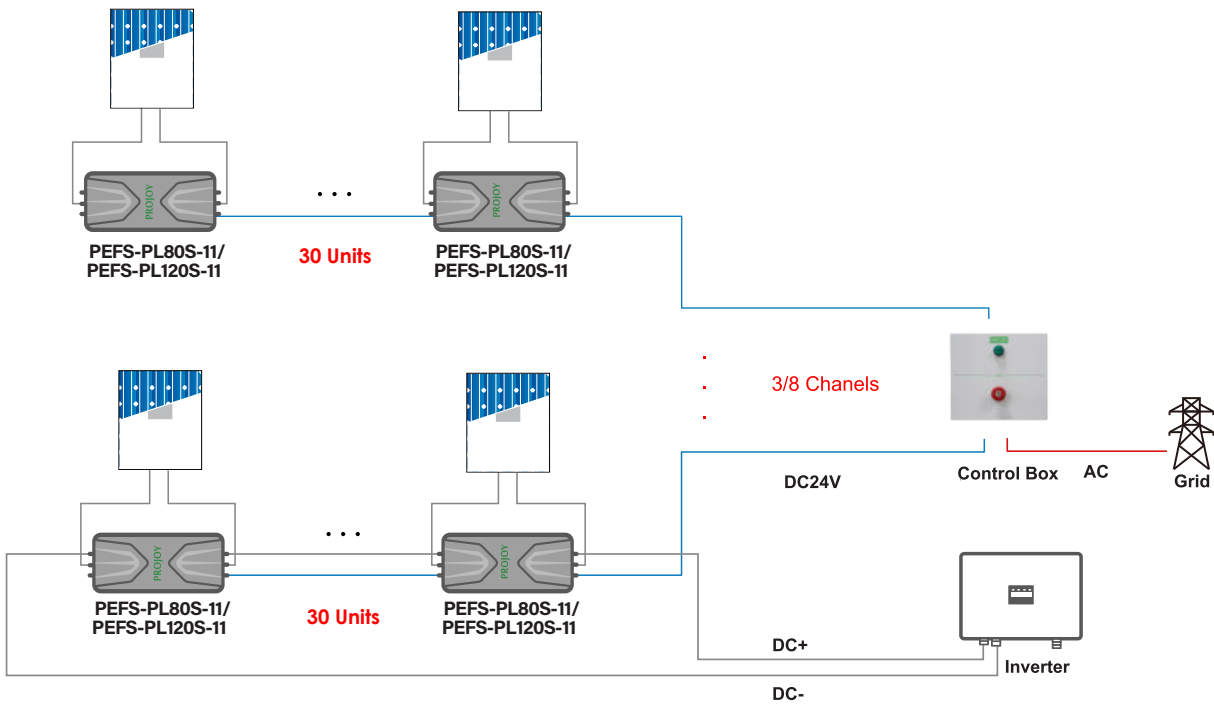

*PEFS-PL120S-11 can connect 1 or 2 modules

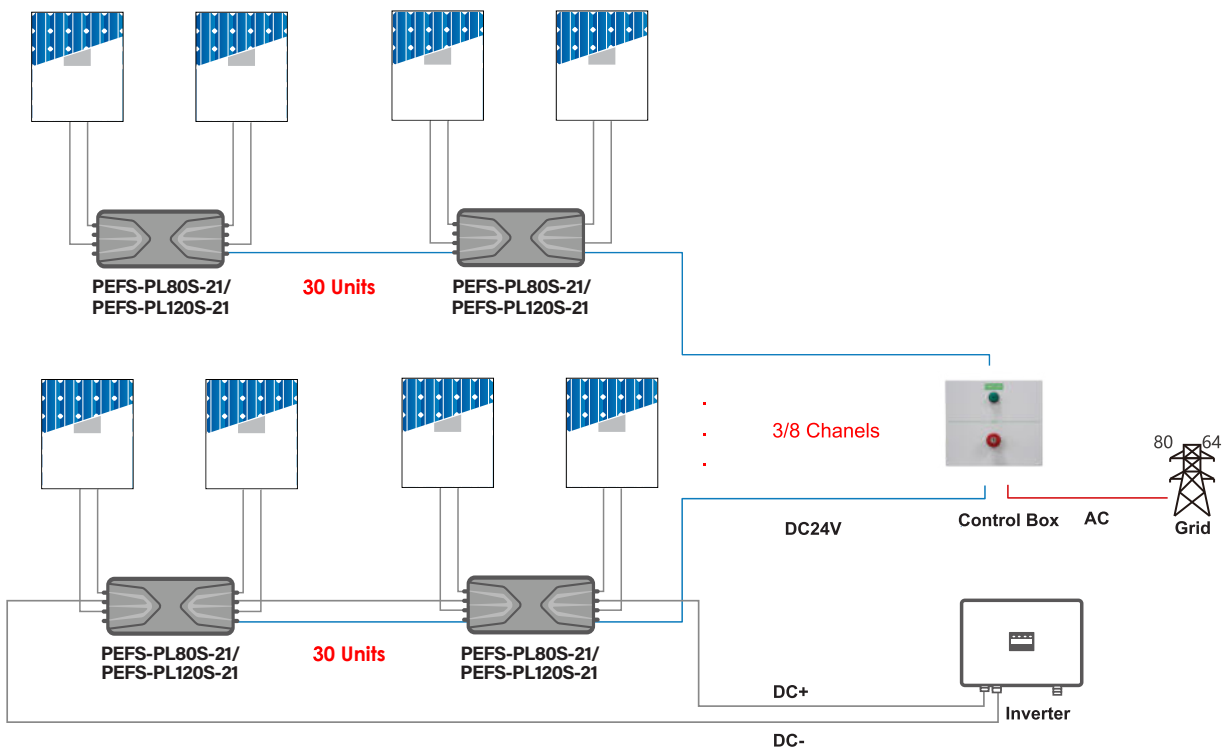

*PEFS-PL120S-21 can connect 2 or 4 modules

5 Technical Specification

Control Box with Power Supply

Model	PCY/PCZS-S-180-31
Operating AC Voltage Range	180V-264 V
Norminal Frequency	50/60 Hz
Output Voltage	24V DC
Output Current / Power	8.8A(3 Channels)
24Vdc Control Cable Size	20 AWG
24Vdc Control Cable Length With Standard Connectors (recommend)	20 m / 30 m / 100 m (Users Purchase By Themselves)
Spare Terminal Connectors	Yes
Maximum PEFS-PL80/120S-11	3*30 Units
Maximum PEFS-PL80/120S-21	3*30 Units
Dimensions (mm)	248*280*70
Lockable	Optional (IP54)
Operating Temperature Range	30°C~+55°C (Can work for 8 hours at 70°C)
Protection Class	IP65
Mounting	Wall Mounted
Maximum Distance (From controller box to the terminal RSD)	250m

Control Box Without Power Supply

Model	PCY/PCZS-S-480-81
Operating AC Voltage Range	180 V-264 V
Norminal Frequency	50/60 Hz
Output Voltage	24V DC
Output Current	17.6A (8 Channels)
24Vdc Control Cable Size	20 AWG
24Vdc Control Cable Length With Standard Connectors (recommend)	20 m / 30 m / 100 m (Users Purchase By Themselves)
Spare Terminal Connectors	Yes
Maximum PEFS-PL80/120S-11 / Per String	8*30 Units
Maximum PEFS-PL80/120S-21 / Per String	8*30 Units
Dimensions (mm)	248*280*70
Lockable	Optional
Operating Temperature Range	30°C~+55°C (Can work for 8 hours at 70°C)
Protection Class	IP65
Mounting	Wall Mounted
Maximum Distance (Last RSD to Controller Box)	250m

6 Trouble Shooting

Problem	Possible Cause	Possible Solution
String Voltage drops to 0V	No mains supply	Check AC power
	power supply failure	Check mains voltage between L&N marked terminals
		Check the end RSD voltage between + & - marked terminals
	Cable disconnected	Check reliability of cable wiring
	Wrong cable wiring	Check the cable wiring correction
String voltage drops	24V Cable disconnected somewhere	Check the cable wiring
	DC Power drops for high temperature	DC power

7 Aftersales service and warranty

7.1 Warranty

Projoy PEFS Series Module Level Rapid Shutdown controller: Up to 25 years lifespan design, which commencing from 3 months later of the manufacturing date. PROJOY will repair or replace any fault unit which is damaged or cannot work normally due to product quality issue. However, for the faults caused by following reasons, PROJOY would do service with charge even under warranty.

- 1) Inappropriate use or installation, self-modification or improper maintenance, etc.:
- 2) Beyond the prescribed scope of use;
- 3) Earthquakes, fires, lightning strikes, abnormal voltages, other natural disasters and secondary disasters, etc.
- 4) Any lost caused by any inappropriate use out of the scope defined in this manual, Projoy will not take the responsibility

7.2 Aftersales service

Please contact Projoy local distributors for after-sales service

1. Beyond the warranty period;
2. No valid quality assurance card and product serial number;
3. Transportation damage;
4. Improper use, operation and modification;
5. Operating in an environment beyond the specified in this manual;
6. Any installation and use beyond the scope specified in relevant international standards;
7. Damage caused by abnormal natural disasters (earthquake, fire, flood, etc.).

8 Contact us

Projoy Electric Co., Ltd.

Tell: +86-512-6878 6489

Web: <https://www.projoy-electric.com/>

Add: No.90 Chunyao Rd, Xiangcheng District, Suzhou, Jiangsu, China