

Economical long-life light sources with plug-in base

Compact fluorescent lamps OSRAM DULUX®
Technical Guide

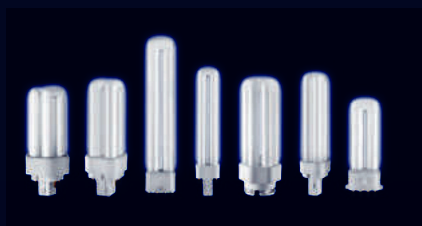

SEE THE WORLD IN A NEW LIGHT



EDITION: 04.2011

Subject to change without notice.

Despite careful review, the possibility of mistakes can't be excluded – no guaranty will be taken.

1	GENERAL	5
1.1	Introduction	5
1.2	The OSRAM DULUX® range	6
1.2.1	Lamps with integrated starter and two-pin base for conventional operation	6
1.2.2	Lamps with four-pin bases for operation with electronic control gear (ECG)	9
1.2.3	High efficiency (HE) lamps for operation with electronic control gear (ECG):	10
1.2.4	Lamps with four-pin bases for conventional or ECG operation	13
1.2.5	Lamps for special Applications:	15
1.3	Economy and suitability	19
1.4	Technical design and operation	20
1.4.1	Radio interference suppression	22
1.5	Which accessories are needed for OSRAM DULUX® lamps?	23
2	LAMP DATA	24
2.1	Geometric data	24
2.1.1	OSRAM DULUX® S	24
2.1.2	OSRAM DULUX® S/E	24
2.1.3	OSRAM DULUX® D	25
2.1.4	OSRAM DULUX® D ES	25
2.1.5	OSRAM DULUX® D/E	25
2.1.6	OSRAM DULUX® T PLUS	26
2.1.7	OSRAM DULUX® T CONSTANT	26
2.1.8	OSRAM DULUX® T/E PLUS	26
2.1.9	OSRAM DULUX® T/E CONSTANT	27
2.1.10	OSRAM DULUX® T/E HE	27
2.1.11	OSRAM DULUX® L	28
2.1.12	OSRAM DULUX® L HE	28
2.1.13	OSRAM DULUX® F	29
2.1.14	OSRAM CFL SQUARE®	30
2.2	Operation modes and electrical data	31
2.2.1	Electronic operation	31
2.2.2	Inductive operation Single-lamp circuit	32
2.2.3	Inductive operation Series circuit	33
2.2.4	Inductive operation Lead-lag circuit	33
2.3	Photometric data	34
2.3.1	Light colours	34
2.3.2	Colour specifications	35
2.3.3	Chromaticity coordinates tolerance fields	35
2.3.4	OSRAM DULUX® light colours	36
2.3.5	Factors affecting colour consistency	37
2.3.6	Spectral distribution	38
2.3.7	Radiation components in the ultra-violet range:	39
2.3.8	Radiation components in the infra-red range	40
2.3.9	Luminous intensity distribution charts	41
2.3.10	Luminance of OSRAM DULUX® lamps	43
2.4	Lamp life and maintenance	44
2.4.1	Definitions	44
2.4.2	Maintenance for OSRAM DULUX® lamps	44
2.4.3	Mortality charts of OSRAM DULUX® lamps	44
2.4.4	Effect of switching operations on lamp life	44

3	CIRCUITS	46
3.1	Operation with electronic control gear (ECG)	46
3.2	Operation with conventional control gear (CCG)	47
3.2.1	<i>Permissible lamp/CCG combinations and system data</i>	47
3.2.2	<i>Compensation</i>	49
3.2.3	<i>Operation of OSRAM DULUX® S/E, D/E und T/E PLUS with external starter and CCG..</i>	50
3.3	Operating on dc sources	51
3.3.1	<i>Compact fluorescent lamps in emergency lighting</i>	52
3.4	Operation with motion detectors and light sensors	53
3.5	Dimensioning of automatic circuit breakers	53
4	OPERATING CHARACTERISTICS	54
4.1	Start-up characteristics	54
4.1.1	<i>Single circuit, inductive operation</i>	54
4.1.2	<i>Series circuit, inductive operation</i>	55
4.2	Starting at low temperatures	55
4.3	Run-up behaviour	56
4.4	Operating values of the lamps as a function of mains voltage	59
4.5	Operating values of the lamps as a function of ambient temperature	60
4.6	Luminous flux as a function of temperature and operating position	62
4.6.1	<i>Luminous flux/temperature graphs for OSRAM DULUX® lamps in general</i>	63
4.6.2	<i>Luminous flux/temperature graphs for OSRAM DULUX® HE base up (horizontal)</i>	63
4.6.3	<i>Luminous flux/temperature graphs for OSRAM DULUX® CONSTANT lamps</i>	64
4.6.4	<i>Luminous flux/temperature graphs for OSRAM DULUX® L SP for outdoor lighting</i>	64
4.6.5	<i>Luminous flux/temperature graphs for OSRAM DULUX® L Constant</i>	65
4.6.6	<i>Operation at high temperatures</i>	66
4.6.7	<i>Operation at low temperatures</i>	66
4.7	Dimming	67
4.7.1	<i>Dimming of OSRAM DULUX CONSTANT lamps</i>	67
4.8	Lamp temperature, safety and limit values	71
4.8.1	<i>Maximum temperatures for OSRAM DULUX® lamps</i>	72
4.8.2	<i>Maximum electrical safety values for OSRAM DULUX® lamps as per IEC 61199</i>	75
5	DATA FOR CONTROL GEAR MANUFACTURERS	77
5.1	Electronic operation	77
5.1.1	<i>Preheating (ECG operation)</i>	77
5.1.2	<i>Starting (ECG operation)</i>	78
5.1.3	<i>Operating data for undimmed lamps</i>	80
5.1.4	<i>Dimming</i>	81
5.2	Magnetic operation	85
5.2.1	<i>Magnetic operation 220 V/230V and 240V, 50Hz/60Hz</i>	85
5.3	Electrical data for the filaments	86
6	ACCESSORIES	87
6.1	Caps and lampholders	87
6.2	Lamp supports	88
6.3	Starters	89

7	MEASURING OSRAM DULUX® COMPACT FLUORESCENT LAMPS.....	90
7.1	Ageing of lamps	90
7.2	Operating position.....	91
7.3	Constant photometric values	91
7.4	Electrical measurements	91
7.5	Temperature measurements.....	92
7.5.1	<i>Ambient temperature.....</i>	<i>92</i>
7.5.2	<i>Cold spot temperature for lamps without amalgam</i>	<i>92</i>
7.5.3	<i>Measuring CONSTANT lamps.....</i>	<i>92</i>
7.6	Reference lamps.....	93
8	OSRAM DULUX® AND THE ENVIRONMENT	94
8.1	Contents	94
8.2	Waste disposal.....	94
8.3	ROHS Directive and conformity for compact fluorescent lamps	95
9	EUROPEAN AND INTERNATIONAL STANDARDS.....	96
9.1	Relevant standards	96
9.1.1	<i>Lamps and caps.....</i>	<i>96</i>
9.1.2	<i>Accessories</i>	<i>96</i>
9.1.3	<i>Luminaires</i>	<i>97</i>
9.1.4	<i>Miscellaneous.....</i>	<i>98</i>
9.1.5	<i>Sources</i>	<i>99</i>
9.2	Declaration of Conformity.....	100
9.3	CE labelling	104
9.4	Energy Efficiency Index.....	104

1 General

1.1 Introduction

The first compact fluorescent lamps (CFLs) appeared on the European market in the early 1980s. Ever since, they have had a significant and lasting effect on light fitting design and lighting applications. Today, CFLs are available in an extremely wide range of models.

They can be divided into two main groups:

- lamps with pin bases and
- lamps with screw bases

Lamps with E27 or E14 screw bases and integrated control gear (electronic or conventional) are available in wattages from 3 to 30 W. They constitute a separate family of lamps.

Examples are the OSRAM DULUX® EL and CIRCOLUX® EL lamps. These ranges are intended as direct replacements for ordinary incandescent light bulbs. For detailed technical information on these lamps, please refer to the brochure titled „OSRAM DULUX® EL Electronic Energy-Saving Lamps – Facts and Technical Data“.

This present guide, however, takes a detailed look at lamps with pin bases.

OSRAM's compact fluorescent lamps with pin bases marketed under the OSRAM DULUX® brand name are available in wattages from 7 to 80 W with luminous flux values of 405 to 6000 lm. This range of values covers a broad spectrum of lamps, including incandescent, fluorescent and HID lamps, with a wide variety of applications.

Lamps with pin bases have a history of constant development, from the single-turn OSRAM DULUX® S models to the latest OSRAM DULUX® L 80 W with CONSTANT Amalgam technology and the DULUX® HE High Efficiency lamp range with up to 100lm/W efficiency. The development of different shapes and wattages has led to various types of light fittings for both, indoor and outdoor lighting. The list includes recessed and surface-mounted light fittings for shops and offices, floor-standing lights, indirect light fittings, workplace and desktop lighting, security lighting, pictogram illumination, street lighting, solar light fittings and downlights.

For downlights in particular, pin-based lamps have been instrumental in determining their design, as each successive round of development has produced increasingly shorter lamps of greater light output.

Compact fluorescent lamps from OSRAM, which offer impressive savings thanks to a luminous efficacy of up to 100 lm/W and a lamp life of up to 20 000 or 36 000 hours for long life range (XT) on ECG operation, are available not only in a wide range of types but also in different light colours. These light colours are classified in colour rendering groups 1B (Ra 80 to 89) and 1A (Ra 90 to 100). The range also includes various models for special applications in medicine, cosmetics and technology.

The following sections present the range of pin-based lamps, their properties, the necessary accessories accompanied by notes on light fitting design, lamp applications and measurement.

1.2 The OSRAM DULUX® range

OSRAM DULUX® lamps are innovative light sources with the following features:

- Small dimensions
- Low power consumption
- High luminous efficacy
- Long life
- Low thermal output
- Different light colours
- Excellent colour rendering
- Wide range of types and wattages

1.2.1 Lamps with integrated starter and two-pin base for conventional operation

OSRAM DULUX® S

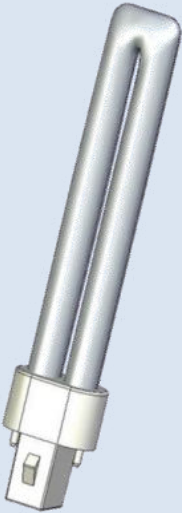

5 W	257 lm
7 W	405 lm
9 W	600 lm
11 W	900 lm

Light colours
LUMILUX® 827, 830, 840, 865*
Red 60**, Green 66**, Blue 67**

* reduced luminous flux. Consult www.osram.com
** lumen value not defined. Consult www.osram.com

With built in glow starter
Only for CCG operation

G23, 2 pin base

Average life time: 10,000 h

OSRAM DULUX® S is a single-turn lamp with a 12 mm tube diameter and G23 two-pin base. The starter components are situated in the lower section of the base. This lamp has already become a classic and is used in a wide range of applications. Many light fittings (wall-mounted, desktop, workplace, low-profile surface-mounted, downlight and outdoor) are built around this basic model of the compact fluorescent lamp.

OSRAM DULUX® D



10 W	600 lm
13 W	900 lm
18 W	1200 lm
26 W	1800 lm

Light colours
LUMILUX® 827, 830, 840

With built in glow starter
Only for CCG operation

G24d, 2 pin base

Average life time: 10,000 h

OSRAM DULUX® D is a lamp with double-turn tubes, which make it much shorter than the S version. Again, the starter components are situated in the lower section of the G24d base. These lamps are used mainly in single or multi-lamp downlights. They can also be found in a wide variety of indoor and outdoor light fittings.

OSRAM DULUX® D ES

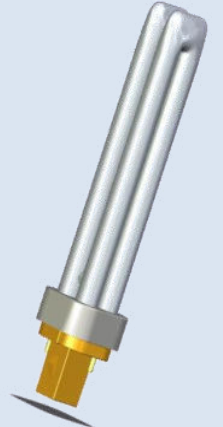

	Ambient temperature	
	25°C	30°C
16 W	1120 lm	1150 lm
23 W	1700 lm	1750 lm

Light colours
LUMILUX® 827, 830, 840,

With built in glow starter
Only for CCG operation

G24d, 2 pin base

Average life time: 10,000 h

OSRAM DULUX® D ES 16 W and 23 W replace the standard DULUX® D 18 W and 26 W versions in existing light fittings.

OSRAM DULUX® T PLUS



13 W	900 lm
18 W	1200 lm
26 W	1800 lm

Light colours
LUMILUX® 827, 830, 840,

With built in glow starter
Only for CCG operation

GX24d, 2 pin base

Average life time:	13 W	3,200 h
	18 W	3,900 h
	26 W	10,000 h

OSRAM DULUX® T PLUS is a version with triple-turn tubes for an extremely short overall length.

The starter components are situated in the lower section of the base. The two-pin base is a GX24d base. This type of lamp is perfect for shallow downlights and can also be used in various indoor and outdoor light fittings.

OSRAM DULUX® T PLUS 13, 18 and 26 W can be used with lamp holder systems for OSRAM DULUX® D 13, 18 and 26 W. The only point to remember is that the upper section of the base on the T version is wider. OSRAM DULUX® T PLUS 13, 18 and 26 W lamps can be operated on the same control gear as OSRAM DULUX® D 13, 18 and 26 W lamps. OSRAM DULUX® S, D, T PLUS and T CONSTANT lamps with two-pin bases (CCG operation) are not suitable for emergency systems or DC operation.

OSRAM CFL SQUARE® 2 pin

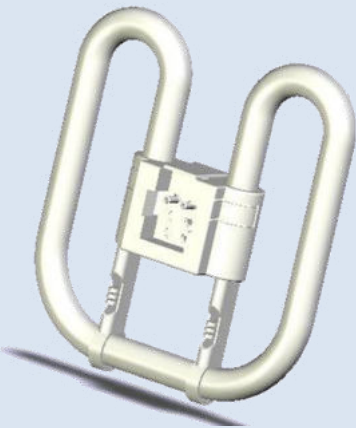

	Ambient temperature	
	25°C	35°C
16 W	1050 lm	1150 lm
28 W	2050 lm	2200 lm

Light colours
LUMILUX® 827, 835

With built in glow starter
For CCG operation only

GR8, 2 pin base

Average life time: 10,000 h

OSRAM CFL SQUARE® lamps are slim compact fluorescent lamps. The square shape provides uniform distribution of light, with no shadows at either end and no dark patches. The lamps are ideal for low-profile wall and ceiling light fittings.

OSRAM CFL SQUARE® lamps with lamp caps GR8, 2 pin base are not suited for emergency systems or DC operation.

1.2.2 Lamps with four-pin bases for operation with electronic control gear (ECG)

OSRAM DULUX® S/E



7 W	405 lm
9 W	600 lm
11 W	900 lm

Light colours
LUMILUX® 827, 830, 840

2G7, 4 pin base

Average life time : 20,000 h for ECG operation

OSRAM DULUX® S/E are similar to OSRAM DULUX® S lamps in their design. The main differences are the four-pin 2G7 base and the lack of an integrated glow starter. These lamps include the benefits of ECG operation, such as improved economy and more comfortable light. ECG operation opens up new applications, notably battery operated camping light fittings and emergency lighting (pictogram illumination).

OSRAM DULUX® D/E



10 W	600 lm
13 W	900 lm
18 W	1200 lm
26 W	1800 lm

Light colours
LUMILUX® 827, 830, 840,

G24q, 4 pin base

Average life time: 20,000 h for ECG operation

OSRAM DULUX® D/E with a G24q base is the four-pin version of the classic OSRAM DULUX® D, designed for ECG operation. In conjunction with suitable control gear, this lamp can also be dimmed.

OSRAM DULUX® D/E XT



18 W	1200 lm
26 W	1800 lm

Light colours
LUMILUX® 830, 840,

G24q, 4 pin base

Average life time: 36,000 h for ECG operation

OSRAM DULUX® D/E XT is the long life version that extends the product range of OSRAM DULUX® D/E lamps. Designed for ECG operation only, these lamps can also be dimmed in conjunction with a suitable control gear.

OSRAM DULUX® T/E PLUS



13 W	900 lm
18 W	1200 lm
26 W	1800 lm
32 W	2400 lm
42 W	3200 lm

Light colours
LUMILUX® 827, 830, 840,

GX24q, 4 pin base

Average life time: 20,000* h on ECG operation
* 13,000 h for 42 W

OSRAM DULUX® T/E PLUS with a GX24q four-pin base is an extremely short lamp with the photometric benefits of triple-turn tubes. Designed for ECG operation, these lamps can also be dimmed in conjunction with a suitable control gear.

OSRAM DULUX® T/E XT



32 W	2400 lm
42 W	3200 lm

Light colours
LUMILUX® 827, 830, 840,

GX24q, 4 pin base

Average life time: 36,000 h on ECG operation

OSRAM DULUX® T/E XT is the long life version that extends the product range of OSRAM DULUX® T/E PLUS lamps. Designed for ECG operation only, these lamps can also be dimmed in conjunction with a suitable control gear.

1.2.3 High efficiency (HE) lamps for operation with electronic control gear (ECG):

The HE lamps have been specially designed, to guarantee more energy savings, thanks to their higher efficiency up to 100lm/W. The High efficiency concept allows the light fitting manufacturers to design new, more energy efficient luminaires and so to save more energy in new installations. Compared to standard DULUX® lamps, the DULUX® HE lamps develop their light flux maximum value at higher ambient temperatures - ca. 35°C, which is getting closer to the real conditions in a compact down light fitting.

The HE range uses a new designed lamp base/holder system. The lamps are not intended to be used as direct retrofits.

OSRAM DULUX® T/E HE



	Ambient temperature	
	25°C	35°C
11 W	810 lm	890 lm
14 W	1050 lm	1175 lm
17 W	1250 lm	1460 lm

Light colours
LUMILUX® 830, 840

GR14q
Twist-lock, 4 pin base

Average life time: 20,000 h for ECG operation

A high efficiency compact fluorescent lamp, available in three wattages:

- DULUX® T/E 11W HE with its dimensions and light output is comparable with DULUX® D/E 13W.
- DULUX® T/E 14W HE is comparable with DULUX® D/E 18W.
- DULUX® T/E 17W HE is similarly comparable with the DULUX® D/E 26W.

So, an energy consumption saving of more than 20% is possible, compared to a standard DULUX® D/E lamp.

The HE technology offers the further advantage, that the lamps develop their optimum light output at an ambient temperature range from 28°C up to 52°C.

35°C is the optimum ambient temperature for the maximum luminous flux. By contrast, standard DULUX® D/E lamps produce maximum luminous flux at 25°C.

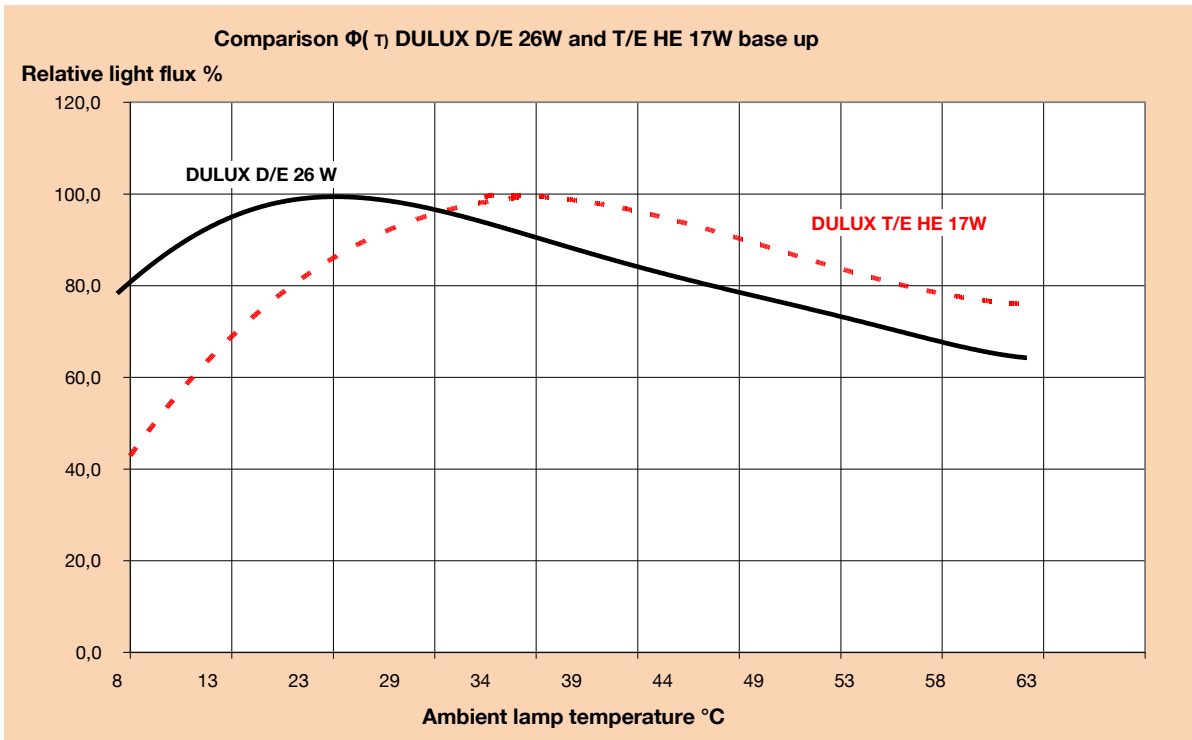

The lamps can only be operated in combination with suitable electronic control gear, and are dimmable in combination with the proper dimmable electronic control gear. A suitable OSRAM control gear range is available and can be supplied together with the lamps.

DULUX® T/E HE lamps have a special designed lamp base/holder system utilizing a twist and lock installing principle. The system is shorter than the standard four-pin base system and the lamps are much easier to install. This opens new possibilities for the design of new light fittings.

OSRAM DULUX® L HE

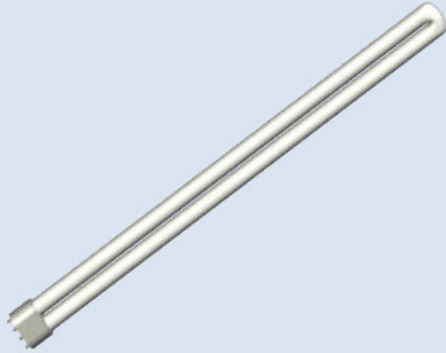

	Ambient temperature	
	25°C	35°C
16 W	1500 lm	1600 lm
22 W	2055 lm	2200 lm
26 W	2470 lm	2600 lm
28 W	2700 lm	2800 lm

Light colours 830, 840

2GX11, 4 pin base

Average life time: 20,000 h for ECG operation

Is a high efficiency compact fluorescent lamp with a very high energy efficiency of 100lm/W. The lamp offers new possibilities by designing new energy and cost efficient lighting solutions.

The DULUX® L HE lamp uses a new lamp base/holder system. So it is not suitable for 1:1 retrofits. DULUX® L HE can only be operated in combination with electronic control gear. A suitable control gear range is available, and can be supplied together with the lamps.

1.2.4 Lamps with four-pin bases for conventional or ECG operation

OSRAM DULUX® L



18 W	1200 lm
24 W	1800 lm
36 W	2900 lm
40 W *	3500 lm
55 W *	4800 lm
80 W *	6000 lm

* Only for ECG operation

Light colours
 LUMILUX® 827, 830, 840, 860**, 880**
 ** reduced luminous flux. Consult www.osram.com

2G11, 4 pin base

Average life time:
 10,000 h for CCG operation
 20,000 h for ECG operation

OSRAM DULUX® L lamps are compact fluorescent lamps with a high luminous flux. They have almost the same luminous flux and power consumption as tubular fluorescent lamps but are less than half as long and are more compact than U-shaped and ring-shaped lamps. OSRAM DULUX® L are the ideal light source for modern space-saving wall and ceiling lighting in offices, shops, exhibition rooms, foyers and canteens. They are also used for display and outdoor lighting.

OSRAM DULUX® L 18, 24 and 36 W lamps can be used with conventional control gear or appropriate electronic control gear, such as QUICKTRONIC®. These lamps can also be dimmed in conjunction with suitable electronic control gear.

If used with conventional control gear and external starter, a power factor correction capacitor is needed to improve voltage current phase shift.

OSRAM DULUX® L XT

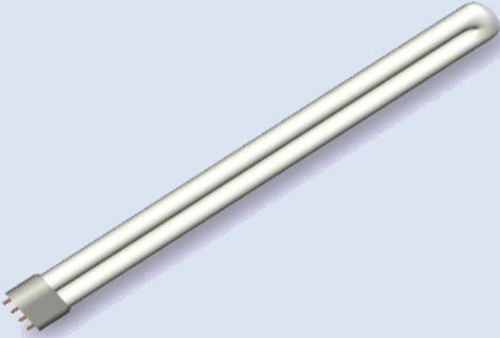

18 W	1200 lm
24 W	1800 lm
36 W	2900 lm
55 W *	4800 lm

* Only for ECG operation

Light colours
LUMILUX® 830, 840

2G11, 4 pin base

Average life time: 36,000 h for ECG operation

OSRAM DULUX® L XT is the long life version that extends the product range of OSRAM DULUX® L lamps. Designed for ECG operation only, these lamps can also be dimmed in conjunction with a suitable control gear.

OSRAM DULUX® F

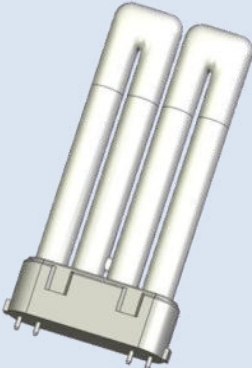

18 W	1100 lm
24 W	1705 lm
36 W	2810 lm

Light colours
LUMILUX® 827, 830, 840

2G10, 4 pin base

Average life time:
10,000 h for CCG operation
20,000 h for ECG operation

OSRAM DULUX® F is a particularly low-profile compact fluorescent lamp with a high luminous flux. Thanks to its compact dimensions, OSRAM DULUX® F is the perfect lamp for area lighting with 2 M to 3 M module light fittings (200 to 300 mm edge length) in the form of square recessed and surface-mounted light fittings or low-profile wall and ceiling light fittings.

OSRAM DULUX® F 18, 24 and 36 W are suitable for CCG and ECG operation. If used with conventional control gear and an external starter, a power factor correction capacitor is needed to improve voltage current phase shift.

The lamps can only be dimmed with appropriate electronic control gear such as QUICKTRONIC®.

OSRAM CFL SQUARE® 4 pin

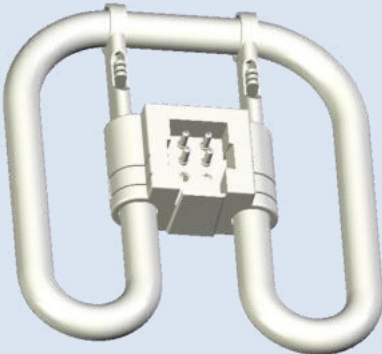

16 W	1050 lm
28 W	2050 lm
38 W	2735 lm

Light colours
LUMILUX® 827, 835

GR10q, 4 pin base

Average life time:
10,000 h for CCG operation
10,000 h for ECG operation

The four-pin base version suitable either for electronic operation with a suitable ECG or for operation with a magnetic ballast and an external starter.

1.2.5 Lamps for special Applications:

In some cases the design of the light fitting, or the application itself, put special demands on the lamps. The lamps may, for example, have to operate at high ambient temperatures or they may have to ignite and operate at low ambient temperatures. There have been special lamps developed, as well as some of the ranges of existing lamps have been modified to meet these special requirements:

- OSRAM DULUX® L SP (four-pin base).

Amalgam lamps:

- OSRAM DULUX® T CONSTANT (two-pin base)
- OSRAM DULUX® T/E CONSTANT (four-pin base)
- OSRAM DULUX® L CONSTANT (four-pin base)

OSRAM DULUX® L SP

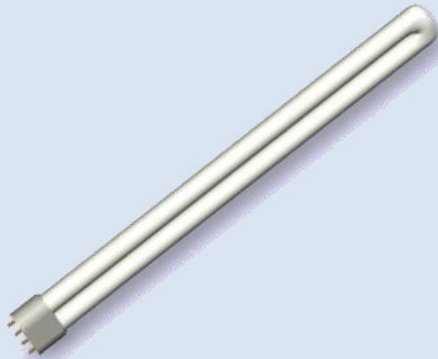

18 W	1200 lm
24 W	1800 lm
36 W	2900 lm

Light colours
LUMILUX® 830, 840

2G11, 4 pin base

Average life time:
10,000 h for CCG operation
20,000 h for ECG operation

OSRAM DULUX® L SP for outdoor lighting has been developed specifically for large volume ventilated light fittings and for cool climates. These lamps produce their maximum luminous flux at a lower temperature than conventional compact lamps (see 4.6.3 Luminous flux/temperature graphs for OSRAM DULUX® CONSTANT lamps, p. 64). Apart from their rounded tube ends, they are identical in construction to OSRAM DULUX® L lamps and are operated with the same conventional or electronic control gear.

Amalgam Lamps

OSRAM DULUX® T CONSTANT and OSRAM DULUX® T/E CONSTANT

with triple-turn tubes have been optimized for constant lumen output under variation of lamp ambient temperature, such as operation in narrow downlights in which high ambient temperatures may occur or outdoor applications. Thanks to their special amalgam technology used, the luminous flux remains more or less constant over a wide range of temperatures (see 4.6.2). CONSTANT lamps are identical in construction to the OSRAM DULUX® T and T/E lamps except for their rounded tube cross-section at the glass tube bend and a shorter discharge tube (about 5 mm shorter).



26 W	1800 lm
-------------	---------

Light colours
LUMILUX® 827, 830, 840,

With built in glow starter
Only for CCG operation only

G24d, 2 pin base

Average life time:
10,000 h for CCG operation

OSRAM DULUX® T CONSTANT has a two-pin GX24d base. These lamps use the same control gear as OSRAM DULUX® D and OSRAM DULUX® T PLUS.



26 W	1800 lm
32 W	2400 lm
42 W	3200 lm

Light colours
LUMILUX® 827, 830, 840,

GX24q, 4 pin base

Average life time:
20,000* h for ECG operation
* 13,000 h for 42 W

OSRAM DULUX® T/E CONSTANT is the four-pin version with a GX24q base. It uses the same electronic control gear as OSRAM DULUX® D/E and T/E. These lamps can be dimmed with certain restrictions (see 4.7.1 Dimming of OSRAM DULUX CONSTANT lamps, p. 67).

These lamps are not suitable for emergency lighting to DIN EN 1838.

OSRAM DULUX® T/E CONSTANT lamps, particularly the high-wattage models, can be used in outdoor light fittings of suitable dimensions.

The luminous flux in relation to the ambient temperature of the DULUX® T/E and DULUX® T/E CONSTANT

- Maximal light flux temperature moved by 20°C to higher temperatures
- Expansion of the temperature range with $\Phi > 90\% \Phi_{\max}$ from 5°C up to 70 °C

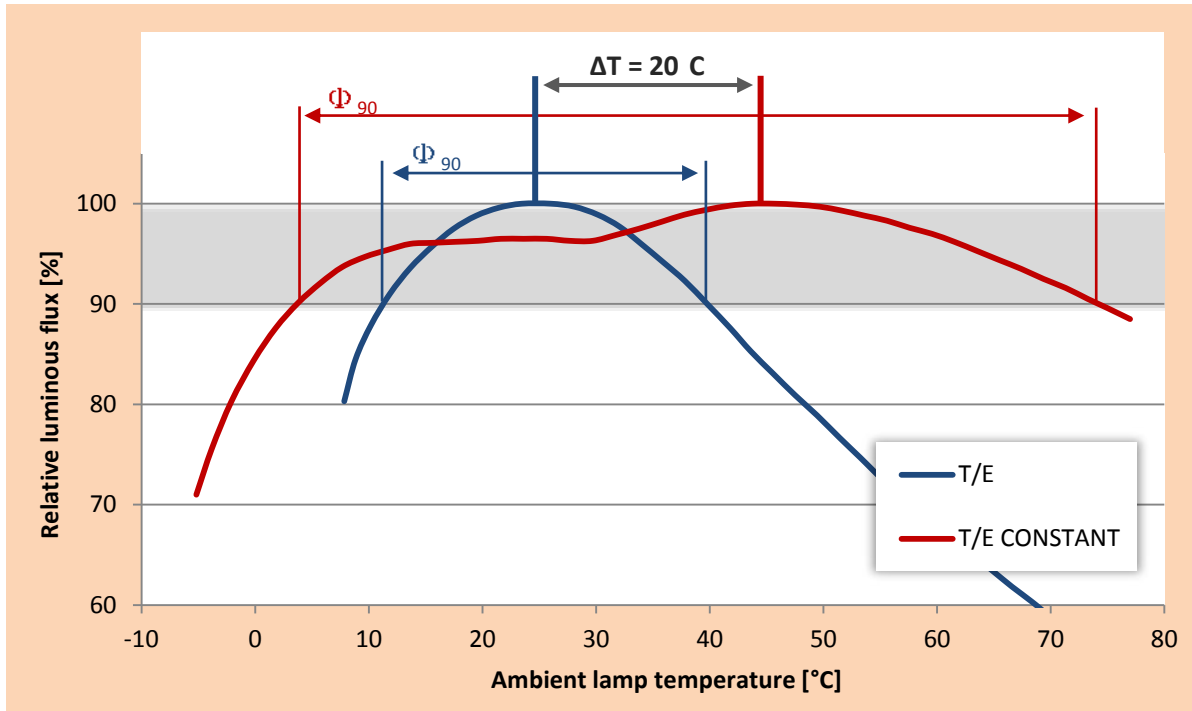

OSRAM DULUX® L CONSTANT

OSRAM DULUX® L CONSTANT is a special version of the DULUX L. The DULUX L also implements the CONSTANT technology and its advantages into the standard DULUX® L lamp type.

The DULUX® L CONSTANT is also suitable for cold, outdoor applications as for the use in light fittings with increased lamp ambient temperatures. The DULUX® L CONSTANT lamps are operated on the same electronic control gear as the standard DULUX® L lamps.

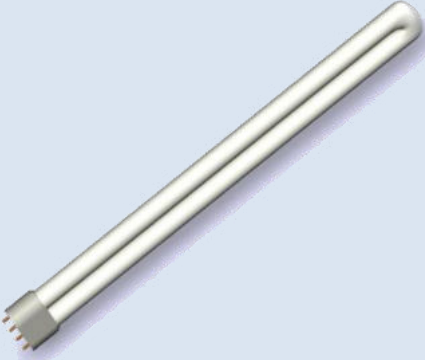

40 W	3500 lm
55 W	4800 lm
80 W	6000 lm

Only for ECG operation

Light colours
LUMILUX® 840

2G11, 4 pin base

Average life time:
20,000 h for ECG operation

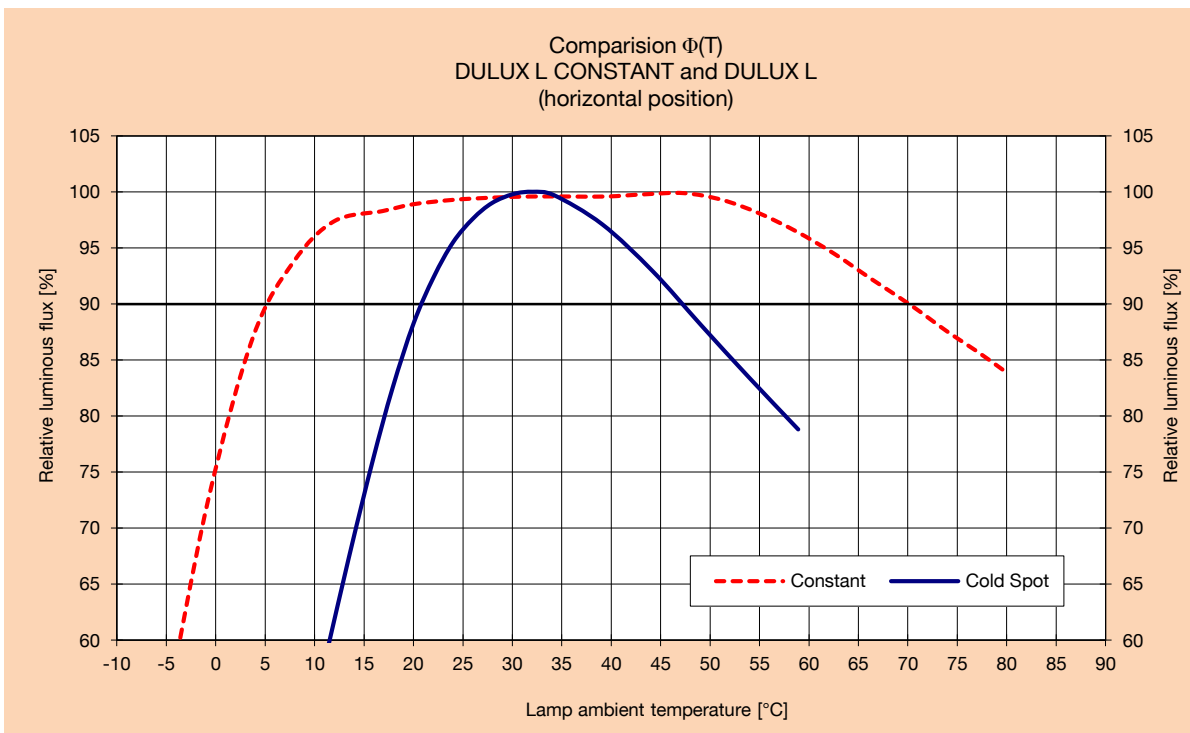

The OSRAM DULUX® L CONSTANT has the same four-pin base 2G11 as the standard DULUX L lamp.

1.3 Economy and suitability

	OSRAM DULUX® T/E HE 14 W	OSRAM DULUX® D/E 18 W	OSRAM DULUX® D 18 W	Incandescent Lamp (Before ErP) 100 W
Lamp wattage	14 W	18 W	18 W	100 W
CCG losses	-	-	6 W	-
ECG losses	2 W	2 W	-	-
Total wattage	16 W	20 W	24 W	100 W
Luminous flux	1200 lm *	1200 lm	1200 lm	1380 lm
Lamp life (average life for a 3 h switching cycle)	20.000 h	20.000 h	10.000 h	1.000 h
Hours burned	20.000 h	20.000 h	2x10.000 h	20x1.000 h
Power consumption during 20.000 hours of operation	320 kWh	400 kWh	480 kWh	2000 kWh
Electricity costs at € 0,13/kWh 20'000 h	€ 41,6	€ 52	€ 62,4	€ 260
Savings over the life of one OSRAM DULUX® lamp (20'000 h)	€ 218,4	€ 208	€ 197,6	

* luminous flux at 35°C, rated luminous flux at 25°C: 1050 lm.

Special application areas for different OSRAM DULUX® lamp types

Lamp	Motion detection	Outdoor light Cold environment	Hot environment	DC operation EL	E-Saving Dimming	Effect Dimming
S, D, T, CFL SQUARE® 2-Pin	+	+	+	+	+	+
D ES, T CONSTANT	+	+	+	+	+	+
S/E, D/E, T/E PLUS	+	+	+	+	+	+
T/E HE, T/E XT, L HE	+	+	+	+	+	+
T/E CONSTANT	+	+	+	+	+	+
L KVG/EVG, L XT	+/+	+	+	+/+	+/+	+/+
L SP KVG/EVG	+/+	+	+	+/+	+/+	+/+
L CONSTANT	+	+	+	+	+	+
F KVG/EVG	+/+	+	+	+/+	+/+	+/+
CFL SQUARE® 4-Pin	+	+	+	+	+	+

+ suitable
+ possible
+ not suitable

1.4 Technical design and operation

The low pressure discharge method of generating light is one of the most economic. It needs only one quarter (or a fifth using an ECG) of the electrical energy which an incandescent lamp with the same light output would need.

In OSRAM DULUX® lamps, as in conventional fluorescent lamps, light is generated by a low-pressure gas discharge. Electrical current is conducted through the tube from one electrode to the other. The electrons excite mercury atoms so that they emit optical radiation. This radiation is converted into visible light by the tri-phosphor coating on the inner wall of the tube.

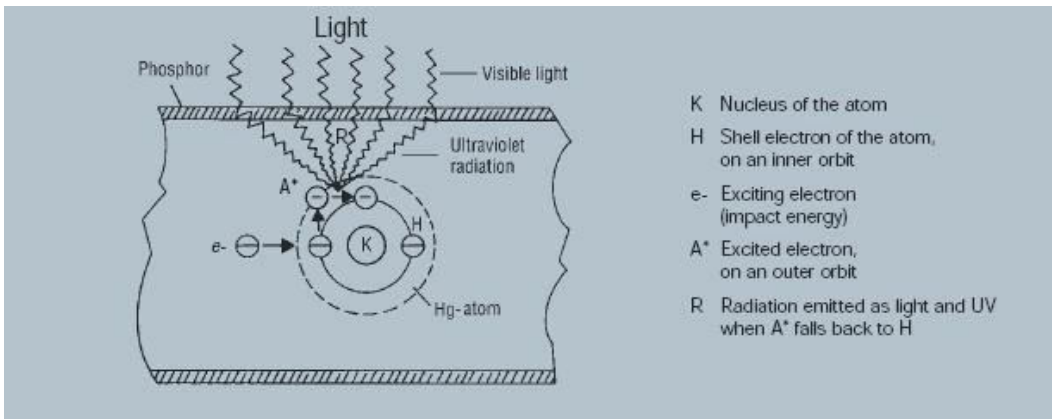

The principle of light generation in a fluorescent lamp

High luminous efficacy (the relationship between luminous flux and power consumption) is achieved when an optimum mercury vapour pressure exists in the discharge tube. This depends on the temperatures on the inner tube wall and is regulated by the vaporisation of mercury and its condensation at the cool zones (cold spot) of the discharge tube.

In contrast to fluorescent lamps, the corners at the top of the discharge tube on an OSRAM DULUX® lamp act as cold spots. The temperature at these cold spots depends to some extent on the burning position of the lamp and the ambient temperature.

Good conditions for luminous flux and lamp performance exist when the temperature at these cold spots is between 40°C and 50°C.

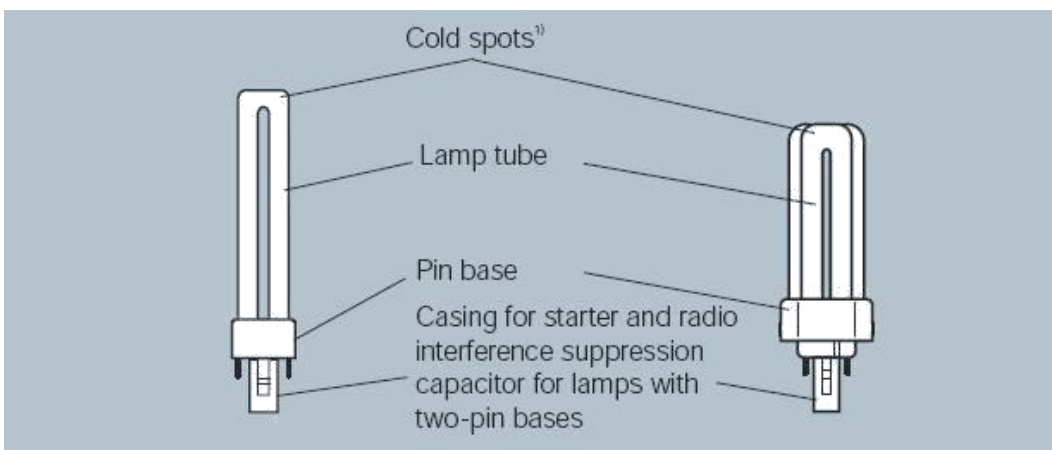

Technical design of OSRAM DULUX® S and OSRAM DULUX® T PLUS

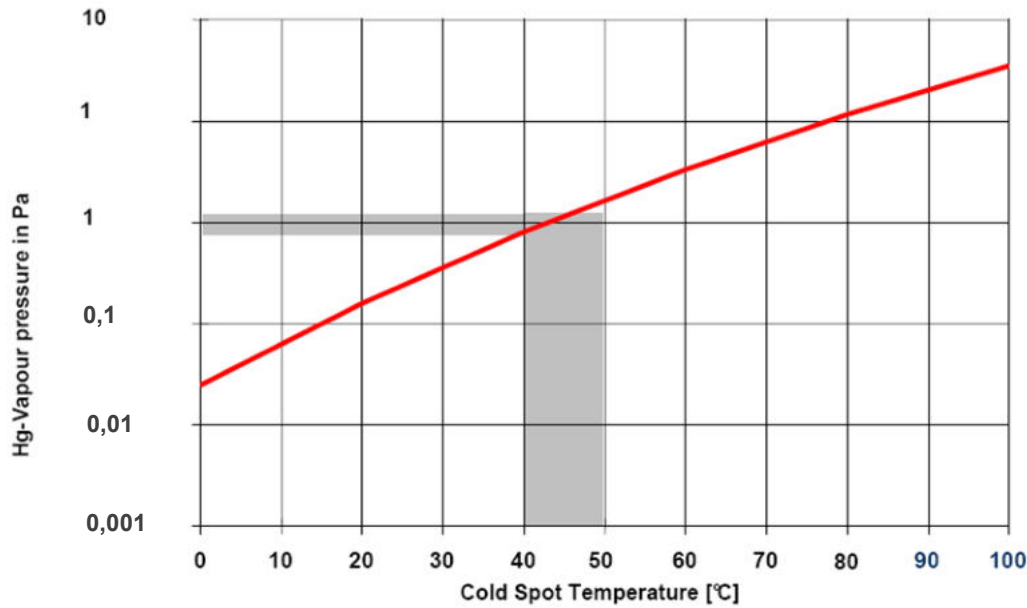

Relation between cold spot temperature in a fluorescent lamp and the mercury vapour pressure in the discharge.

OSRAM DULUX® CONSTANT (amalgam lamps)

In contrast to standard cold spot lamps, OSRAM DULUX® CONSTANT (amalgam lamps) were specially designed to achieve the optimum light output over a wide ambient temperature range. CONSTANT technology enables the use of fluorescent lamps in applications where very high or on the other hand very low lamp-ambient temperatures prevail. Circumstances, where the cold spot fluorescent lamp technology already suffers on a significant light flux depression.

CONSTANT lamps use amalgam and its special physical properties to control the vapour pressure in the lamp. Amalgam is an alloy consisting of mercury and different metals such as Bi, In, Ag. The Hg-vapour pressure (and consequently the luminous flux) is then controlled by the composition and the temperature of the amalgam. A CONSTANT lamp does not have a cold spot like a conventional lamp. The amalgam is located either in a tube-end tip inside of the socket, or on the framework, mounted on one of the electrodes.

Amalgam generally needs a higher operation temperature itself, compared to the liquid Hg in a cold spot controlled lamp. This causes a certain delay (time shift) on the run-up behaviour. In order to shorten the run-up time of the CONSTANT lamp, a second, so called run-up amalgam flag is installed in the close vicinity of the emitter coil. The run-up amalgam is heated very quickly by the coil and releases a certain amount of mercury to the discharge, which speeds up the run-up of the lamp luminous flux.

The use of amalgam enables a significantly expanded temperature range with optimal Hg vapour pressure and consequently, a lamp light output above 90% of the nominal. (See chart below).

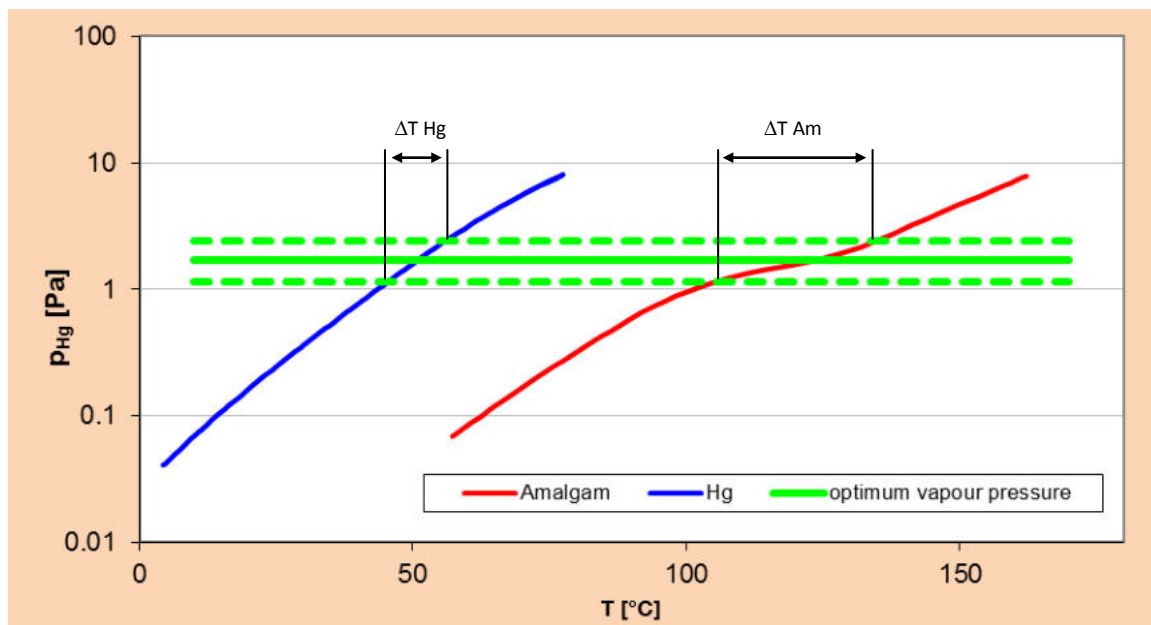

Hg-Vapour pressure in relation to the mercury (blue) and amalgam temperature (red).

The CONSTANT amalgam is an alloy with a high operation temperature and a wide homogenous temperature range with optimum Hg-vapour pressure.

The high temperature amalgam is implemented in the OSRAM DULUX® CONSTANT lamp range like the DULUX® L CONSTANT, DULUX® T/E CONSTANT or the T5 HO CONSTANT double-capped fluorescent lamps, which are suitable for the use in cold and hot ambient temperature environments, in conjunction with proper designed light fittings.

1.4.1 Radio interference suppression

Even if used with conventional control gear (50/60 Hz), gas discharge lamps generate electromagnetic radiation in the HF range. This radiation, however, has such a low energy, that radio and television transmissions are normally not affected. The HF energy is dissipated as radiation and via cables. With an increasing distance, the radiated energy decreases so fast ($1/r^2$), that the radiation component about one meter from the source is lower than the level of ambient noise.

To prevent interference being carried over the cables, OSRAM DULUX® lamps with two-pin bases have built-in interference suppression capacitors:

An interference suppression capacitor is also built into the external starter used for lamps with four-pin bases that are being operated on conventional control gear. In the case of electronic control gear, ECG manufacturers are responsible to ensure that their products meet the relevant radio interference suppression requirements (CISPR 15 or EN 55015). In addition, interference suppression will also depend on the way in which cables are routed in the light fitting; this factor may be quite considerable. The light fitting manufacturer must ensure that the light fitting has adequate radio interference suppression properties.

If an additional interference suppression capacitor is installed in the light fitting, it has to be connected parallel with the mains and not with the lamp.

Lamps with two-pin bases	Interference suppression capacitor [nF]
OSRAM DULUX® S 5 W, 7 W, 9 W, 11 W	3,3
OSRAM DULUX® D 10 W, 13 W	3,3
OSRAM DULUX® D 18 W, 26 W	1,2
OSRAM DULUX® D ES 16 W, 23 W	1,2
OSRAM DULUX® T PLUS 13 W	3,3
OSRAM DULUX® T PLUS 18 W, 26 W ₁	1,2
OSRAM CFL SQUARE®	*

1) Also for the CONSTANT versions

* In preparation

1.5 Which accessories are needed for OSRAM DULUX® lamps?

As it is the case with fluorescent lamps, OSRAM DULUX® compact fluorescent lamps (CFLs) require suitable control gears. A distinction is made between lamps with two-pin bases for operation on conventional (magnetic) control gear (CCG) and lamps with four-pin bases for operation on electronic control gear (ECG).

With conventional control gear, a magnetic ballast is used to limit the lamp current and, in conjunction with the starter situated in the lower section of the base (on OSRAM DULUX® S, D and T, CFL SQUARE® 2 pin – centre housing) to ignite the lamp. OSRAM DULUX® L, F and the OSRAM CFL SQUARE® with four-pin base lamps, operated with conventional control gear require an external starter.

OSRAM DULUX® D 18 W and OSRAM DULUX® T 18 W need special conventional control gear, adjusted to a lamp current of 220 mA. Operation of these lamps on CCG for double-capped fluorescent lamps 18 W with a lamp current of 370 mA will overload the lamps. This will cause blackening of the lamp glass in the electrode region and considerably reduce the lamp life time.

Conventional control gears (CCG) are available in different versions (e.g. with integrated lamp holder or integrated in the mains plug). For some types of lamps, it is possible to connect two lamps in series in conjunction with suitable control gear.

CCG operation is generally an inductive form of operation. In connection with suitable close-tolerance capacitors, capacitive operation (choke and capacitor in series) is also possible. To maintain the prescribed operating and preheating values, close-tolerance capacitors (c.f. IEC 61049) and chokes (c.f. IEC 60920) from renowned manufacturers are needed for series compensation – dielectric strength of the capacitors 450 V ac. However, this mode of operation is suitable only for a few types of lamp (see 3.2).

In addition to what is generally referred to as standard control gear, the group of inductive control gear includes low-loss gear (LLG). As their name suggests, this type of control gear is characterized by its low power loss.

Operation of single-capped fluorescent lamps with electronic control gear (ECG), best available technology (BAT) is a much better option. Apart from the benefits of more comfortable light, longer lamp life and greater luminous efficacy from the system (lamp + ECG), the functions of ignition, current limitation and compensation are all integrated in the ECG. Most ECGs are also suitable for operation on direct current (which means they can be used in emergency lighting systems) and comply with safety standards (automatic switch-off of failed lamps with end of lamp life detection, etc.). There are ECG models for most single and double-lamp arrangements. Some models have an integrated lamp holder (e.g., DULUXTRONIC®).

OSRAM DULUX® lamps are equipped with pin bases. Appropriate lamp holders are available as standard products from all leading manufacturers in a wide variety of designs (e.g., surface-mounting and push-in lampholders for screw or clamp mounting; see 6.1).

OSRAM DULUX® L lamps need a lamp support in addition to the lampholder. Lamp supports are optional for other OSRAM DULUX® lamps, such as the OSRAM DULUX® F (see 6.2 Lamp supports, p. 88).

2 Lamp data

2.1 Geometric data

Single capped lamp geometry is defined by parameters giving the diameter and the length of the lamp. For lamp length two parameters are important to know. There is an overall length which describes the total distance from the very beginning to the end of the lamp and which is called „Overall length“ in this document. Sometimes it might be also called “rated overall length”. This length is important to know to allow enough free space for lamp insertion and withdrawal in a luminaire. It might include the length of pins if they surmount the lower lamp end or the length of a cap guide post. The second parameter corresponds to the maximum length as it is given in IEC which lasts from the lamp cap reference plane to the lamp top. This is called “maximum length” in this document. Sometimes it might be called “rated length” in technical specifications. This dimension describes the length of the lamp which is visible if the lamp is inserted in the holder.

2.1.1 OSRAM DULUX® S

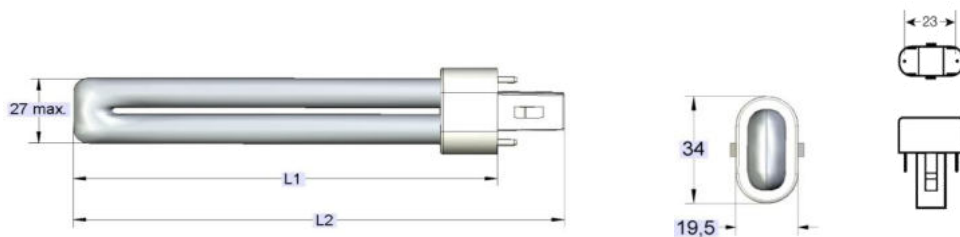

Type	Maximum length ¹⁾ L1 mm	Maximum length ¹⁾ L2 mm	Maximum length L1 IEC mm	Base
OSRAM DULUX® S 5 W	85	108	85	G 23
OSRAM DULUX® S 7 W	114	137	115	G 23
OSRAM DULUX® S 9 W	144	167	145	G 23
OSRAM DULUX® S 11 W	214	237	215	G 23

1) -4mm tolerance
 Base – IEC/EN60061-1, Sheet 7004-69

2.1.2 OSRAM DULUX® S/E

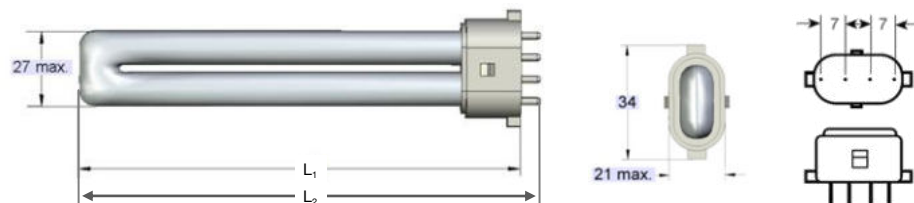

Type	Maximum length ¹⁾ L1 mm	Maximum length L1 IEC mm	Maximum length L2 mm	Base
OSRAM DULUX® S/E 7 W	114	115	119	2G7
OSRAM DULUX® S/E 9 W	144	145	149	2G7
OSRAM DULUX® S/E 11 W	214	215	219	2G7

1) -4 mm tolerance
 Base – IEC/EN60061-1, Sheet 7004-102

2.1.3 OSRAM DULUX® D

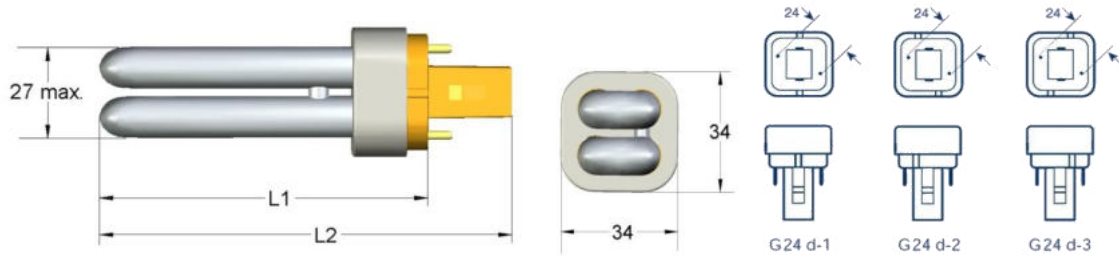

Type	Maximum length ¹⁾ L1 mm	Maximum length ¹⁾ L2 mm	Maximum length L1 IEC mm	Base
OSRAM DULUX® D 10 W	87	110	95	G24 d-1
OSRAM DULUX® D 13 W	115	138	130	G24 d-1
OSRAM DULUX® D 18 W	130	153	140	G24 d-2
OSRAM DULUX® D 26 W	149	172	160	G24 d-3

¹⁾ - 4 mm tolerance
 Base – IEC/EN60061-1, Sheet 7004-78

2.1.4 OSRAM DULUX® D ES

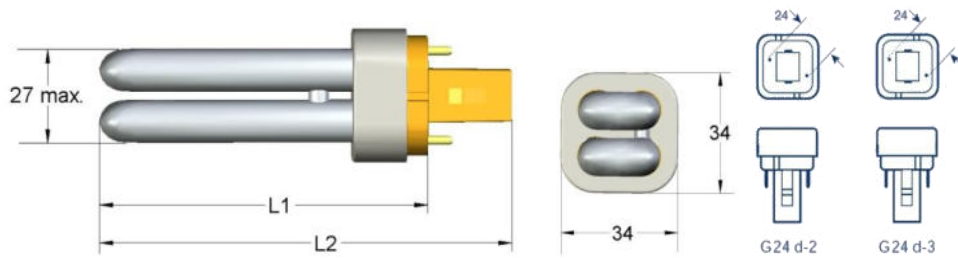

Type	Maximum length ¹⁾ L1 mm	Maximum length ¹⁾ L2 mm	Maximum length L1 IEC mm	Base
OSRAM DULUX® D ES 16 W	130	153	140	G24 d-2
OSRAM DULUX® D ES 23 W	149	172	160	G24 d-3

¹⁾ - 4 mm tolerance
 Base – IEC/EN60061-1, Sheet 7004-78

2.1.5 OSRAM DULUX® D/E

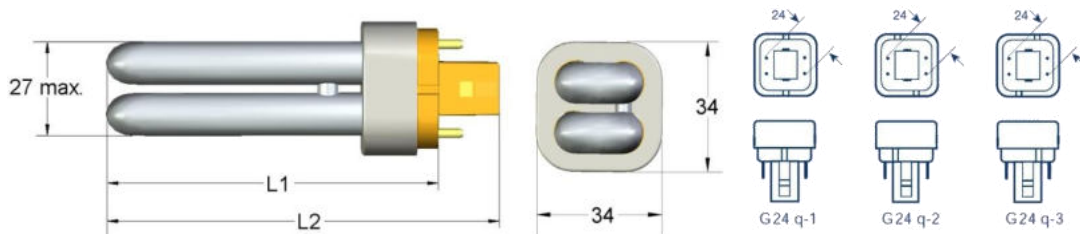

Type	Maximum length ¹⁾ L1 mm	Maximum length ¹⁾ L2 mm	Maximum length L1 IEC mm	Base
OSRAM DULUX® D/E 10 W	87	103	95	G24 q-1
OSRAM DULUX® D/E 13 W	115	131	130	G24 q-1
OSRAM DULUX® D/E 18 W	130	146	140	G24 q-2
OSRAM DULUX® D/E 26 W	149	165	160	G 24 q-3

¹⁾ - 4 mm tolerance
 Base – IEC/EN60061-1, Sheet 7004-78. Same dimensions for DULUX® D/E XT versions.

2.1.6 OSRAM DULUX® T PLUS

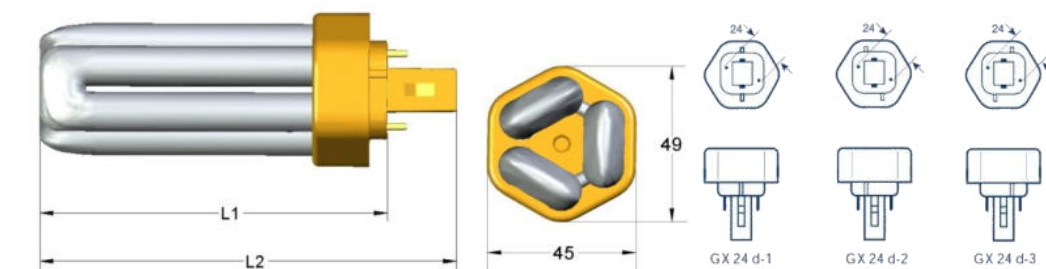

Type	Maximum length ¹⁾ L1 mm	Maximum length ¹⁾ L2 mm	Maximum length L1 IEC mm	Base
OSRAM DULUX® T PLUS 13 W	90	113	90	GX24 d-1
OSRAM DULUX® T PLUS 18 W	101	124	110	GX24 d-2
OSRAM DULUX® T PLUS 26 W	116	139	130	GX24 d-3

¹⁾ -4 mm tolerance
 Base – IEC/EN60061-1, Sheet 7004-78

2.1.7 OSRAM DULUX® T CONSTANT

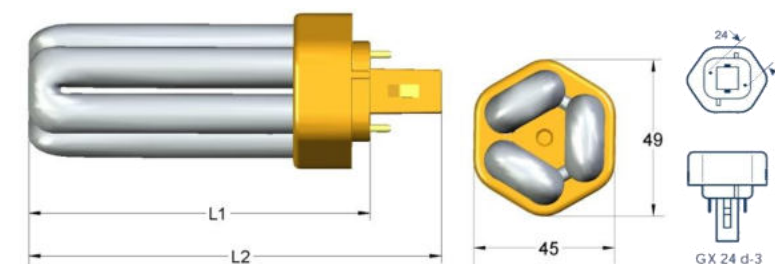

Type	Maximum length ¹⁾ L1 mm	Maximum length ¹⁾ L2 mm	Maximum length L1 IEC mm	Base
OSRAM DULUX® T 26 W CONSTANT	112	135	130	GX24 d-3

¹⁾ - 4 mm tolerance
 Base – IEC/EN60061-1, Sheet 7004-78

2.1.8 OSRAM DULUX® T/E PLUS

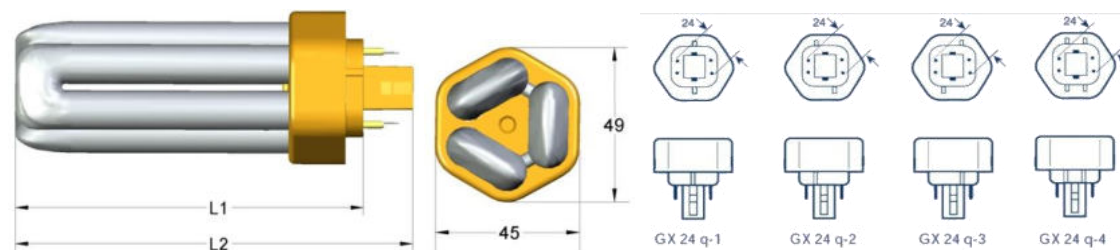

Type	Maximum length ¹⁾ L1 mm	Maximum length ¹⁾ L2 mm	Maximum length L1 IEC mm	Base
OSRAM DULUX® T/E PLUS 13 W	90	106	90	GX24 q-1
OSRAM DULUX® T/E PLUS 18 W	101	117	110	GX24 q-2
OSRAM DULUX® T/E PLUS 26 W	116	132	130	GX24 q-3
OSRAM DULUX® T/E PLUS 32 W	132	148	145	GX24 q-3
OSRAM DULUX® T/E PLUS 42 W	153	169	155	GX24 q-4

¹⁾ -4 mm tolerance
 Base – IEC/EN60061-1, Sheet 7004-78
 Same dimensions for DULUX® T/E XT versions.

2.1.9 OSRAM DULUX® T/E CONSTANT

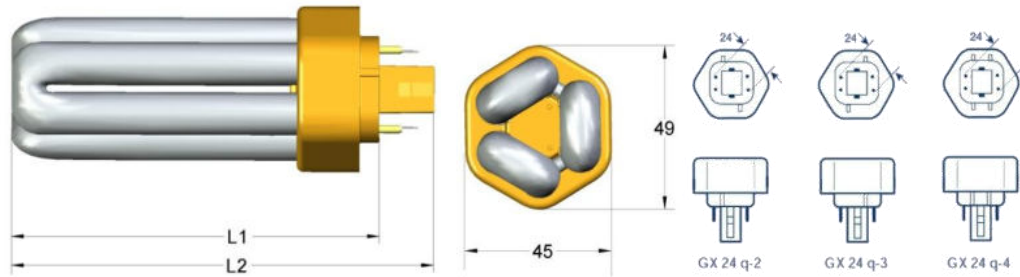

Type	Maximum length ¹⁾ L1 mm	Maximum length ¹⁾ L2 mm	Maximum length L1 IEC mm	Base
OSRAM DULUX® T/E 18 W CONSTANT	97	113	110	GX24 q-2
OSRAM DULUX® T/E 26 W CONSTANT	112	128	130	GX24 q-3
OSRAM DULUX® T/E 32 W CONSTANT	128	144	145	GX24 q-3
OSRAM DULUX® T/E 42 W CONSTANT	149	165	155	GX24 q-4

¹⁾ -4 mm tolerance
 Base – IEC/EN60061-1, Sheet 7004-78

2.1.10 OSRAM DULUX® T/E HE

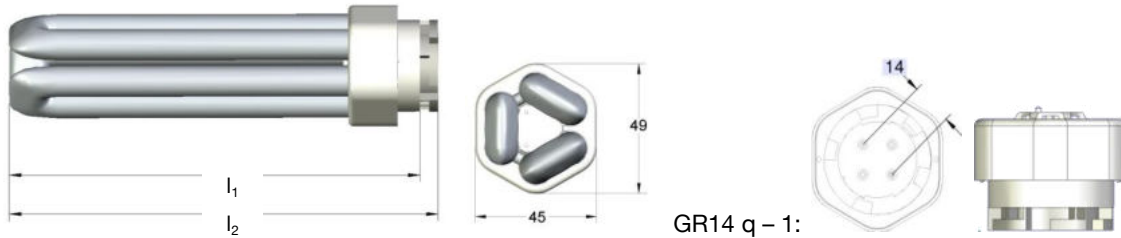

Type	Maximum length ¹⁾ L1 mm	Maximum length ¹⁾ L2 mm	Maximum length L2 IEC C mm	Base
OSRAM DULUX® T/E HE 11 W	106	112	120	GR14q-1
OSRAM DULUX® T/E HE 14 W	123	129	140	GR14q-1
OSRAM DULUX® T/E HE 17 W	140	146	150	GR14q-1

¹⁾ - tolerance -4 mm
 Base – IEC/EN60061-1, Sheet 7004-157-1

2.1.11 OSRAM DULUX® L

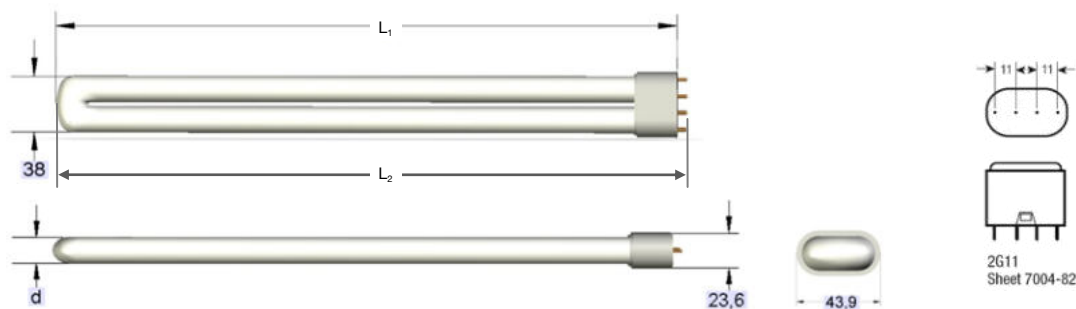

Type	Maximum length ₁₎ L1 mm	Maximum length L1 IEC mm	Maximum length L2 mm	Tube diameter d mm	Base
OSRAM DULUX® L 18 W ₂₎	217	225	222	17.5	2G11
OSRAM DULUX® L 24 W ₂₎	317	320	322	17.5	2G11
OSRAM DULUX® L 36 W ₂₎	411	415	416	17.5	2G11
OSRAM DULUX® L 40 W ₂₎₃₎	533	535	538	17.5	2G11
OSRAM DULUX® L 55 W ₂₎₃₎	533	535	538	17.5	2G11
OSRAM DULUX® L 80 W ₂₎₃₎	565	565	570	17.5	2G11

- 1) - 5 mm tolerance
 2) OSRAM DULUX- L lamps require a lamp support (see 6.2 Lamp supports, p. 88)
 3) Same for DULUX L CONSTANT
 Base - IEC/EN60061-1, Sheet 7004-82

Same dimensions for DULUX- L XT versions.

2.1.12 OSRAM DULUX® L HE

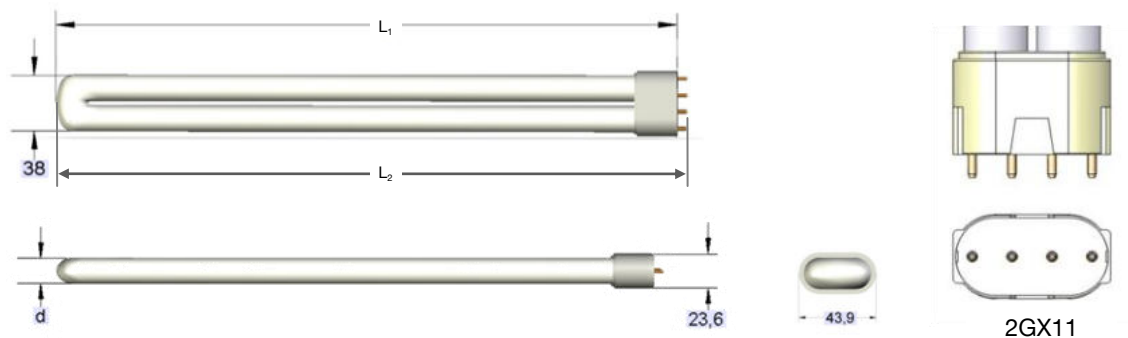

Type	Maximum length ₁₎ L1 mm	Maximum length L1 IEC mm	Maximum length L2 mm	Base	Corresponding geometry ₂₎
OSRAM DULUX® L HE 16 W	317	320	322	2GX11	OSRAM DULUX® L 24 W
OSRAM DULUX® L HE 22 W	411	415	416	2GX11	OSRAM DULUX® L 36 W
OSRAM DULUX® L HE 26 W	533	535	538	2GX11	OSRAM DULUX® L 55 W
OSRAM DULUX® L HE 28 W	565	565	570	2GX11	OSRAM DULUX® L 80 W

- 1) tolerance -5 mm
 2) Information for the light fitting manufacturer
 Base - IEC/EN60061-1, Sheet 7004-82A-1

2.1.13 OSRAM DULUX® F

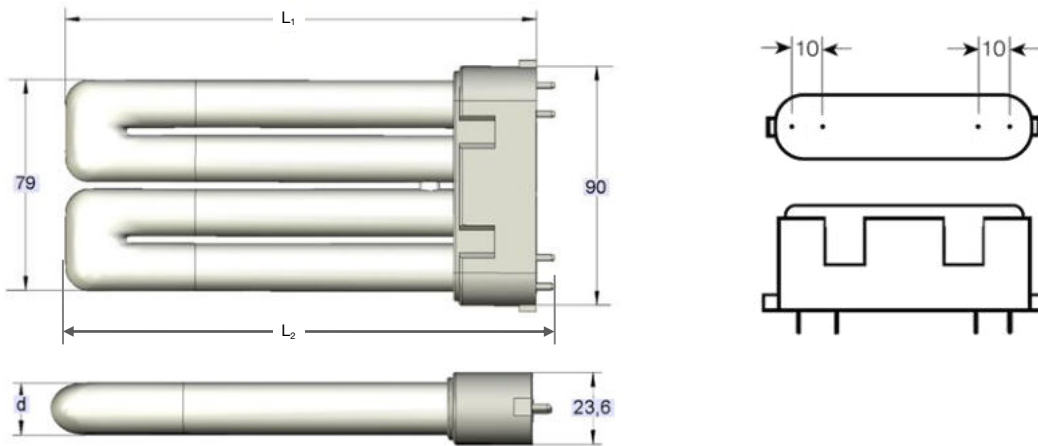

Type	Maximum length ¹⁾ L1 mm	Maximum length L1 IEC mm	Maximum length L2 mm	Tube diame- ter d mm	Base
OSRAM DULUX® F 18 W	122	122	127	17.5	2G10
OSRAM DULUX® F 24 W	165	165	170	17.5	2G10
OSRAM DULUX® F 36 W	217	217	222	17.5	2G10

¹⁾ -4 mm tolerance

Base – IEC/EN60061-1, Sheet 7004-118

2.1.14 OSRAM CFL SQUARE®

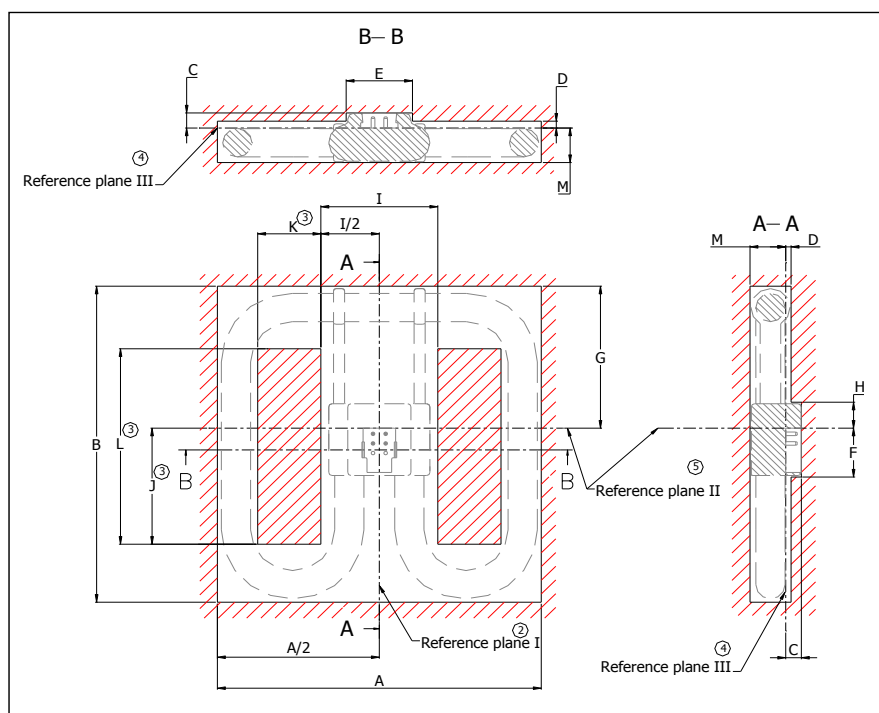
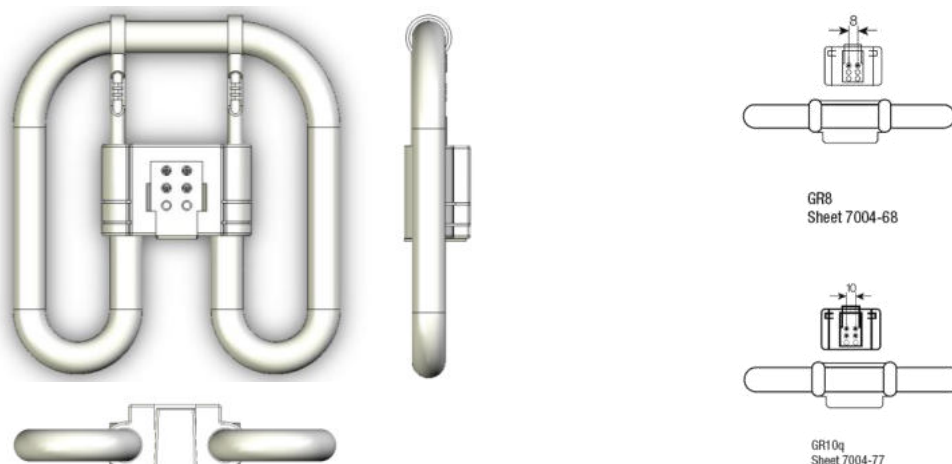

Maximum lamp outline (IEC) in mm

Type	A	B	C	D	E	F	G
OSRAM CFL SQUARE® 16 W	138	141	9.9	4.5	42	33	57
OSRAM CFL SQUARE® 28 W , 38W	205	207	9.9	4.5	42	33	93

Type	H	I	J	K	L	M
OSRAM CFL SQUARE® 16 W	8	64	51	19	73	17.5
OSRAM CFL SQUARE® 28 W , 38W	17	74	76	39	125	22.6

Base - IEC/EN 60061-1

2.2 Operation modes and electrical data

2.2.1 Electronic operation

Only OSRAM DULUX® lamps with four-pin bases are suitable for electronic operation.

In particular, OSRAM DULUX® L 40 W, 55 W and 80 W; OSRAM DULUX® T/E 32 W, 42 W; OSRAM DULUX® T/E HE and L HE are approved exclusively for electronic operation.

Single-lamp and two-lamp operation are the most common arrangements for ECG operation.

The following table shows the data for reference lamps:

Measurement conditions according to IEC 60901:

- Operation on reference gear
- Operating frequency 25 kHz
- Ambient temperature 25°C
- Lamps aged for 100 hours
- Base-up position for OSRAM DULUX® S/E, D/E, T/E, T/E HE, T/E CONSTANT
- Horizontal position for OSRAM DULUX® L, L HE, F, CFL SQUARE

Lamp reference	Rated luminous flux lm	Rated lamp wattage W	Luminous efficacy lm/W	Arc voltage V	Lamp current mA
OSRAM DULUX® S/E 7W	405	6.5	62	37	175
OSRAM DULUX® S/E 9W	600	8	75	48	170
OSRAM DULUX® S/E 11W	900	11	82	75	150
OSRAM DULUX® D/E 10W	600	9.5	63	51	190
OSRAM DULUX® D/E 13W	900	12.5	72	77	165
OSRAM DULUX® D/E 18W ₅₎	1200	16.5	73	80	210
OSRAM DULUX® D/E 26W ₅₎	1800	24	75	80	300
OSRAM DULUX® T/E PLUS 13W	900	12.5	72	77	165
OSRAM DULUX® T/E PLUS 18W _{1) 5)}	1200	16.5	73	80	210
OSRAM DULUX® T/E PLUS 26W _{1) 5)}	1800	24	75	80	300
OSRAM DULUX® T/E PLUS 32W _{1) 5)}	2400	32	75	100	320
OSRAM DULUX® T/E PLUS 42W _{1) 5)}	3200	43	74	135	320
OSRAM DULUX® L 18W _{4) 5)}	1200	16	75	50	320
OSRAM DULUX® L 24W _{4) 5)}	1800	22	82	75	300
OSRAM DULUX® L 36W _{4) 5)}	2900	32	91	90	360
OSRAM DULUX® L 40W ₃₎	3500	40	88	126	320
OSRAM DULUX® L 55W _{3) 5)}	4800	55	87	101	550
OSRAM DULUX® L 80W ₃₎	6000	80	75	145	555
OSRAM DULUX® F 18W	1100	16	69	50	320
OSRAM DULUX® F 24W	1700	22	77	75	300
OSRAM DULUX® F 36W	2800	32	88	90	360
OSRAM DULUX® T/E 11W HE*	810	11.4	71	80	150
OSRAM DULUX® T/E 14W HE*	1050	14.4	73	100	150
OSRAM DULUX® T/E 17W HE*	1250	17.4	72	120	150
OSRAM DULUX® L 16W HE*	1500	15.7	96	147	190
OSRAM DULUX® L 22W HE*	2055	21.4	96	147	190
OSRAM DULUX® L 26W HE*	2470	25.8	96	147	190
OSRAM DULUX® L 28W HE*	2700	27.9	97	147	190
CFL SQUARE 16W	1050	15	70	84	180
CFL SQUARE 28W	2050	24.5	84	95	260
CFL SQUARE 38W	2735	34.5	79	97	355

*) Values for an ambient temperature of 25°C, maximal values at ambient temperature of 35°C.

- 1) Also as the „CONSTANT“ version
- 2) Only as the „CONSTANT“ version
- 3) Also as the DULUX: L CONSTANT
- 4) Also as DULUX L SP
- 5) Also as XT version

2.2.2 Inductive operation Single-lamp circuit

Measurement conditions according to IEC 60901:

- 220 V / 50 Hz supply voltage¹⁾
- Operation on reference gear
- Ambient temperature 25°C
- Lamps aged 100 hours
- Base-up position for OSRAM DULUX® S, D, T PLUS
- Horizontal position for OSRAM DULUX® L, F and CFL SQUARE®

Lamp reference	Luminous flux lm	Lamp Wattage W	Luminous efficacy lm/W	Arc Voltage V	Lamp Current mA	Calibration current mA	Impedance Ω	Power factor
OSRAM DULUX® S 5W	257	5.4	48	35	180	170	1180	0.12
OSRAM DULUX® S 7W	405	7.1	57	47	175	170	1180	0.12
OSRAM DULUX® S 9W	600	8.7	67	60	170	170	1180	0.12
OSRAM DULUX® S 11W	900	11.8	76	91	155	170	1180	0.12
OSRAM DULUX® D 10W	600	10	60	64	190	190	1070	0.12
OSRAM DULUX® D 13W	900	13	69	91	175	165	1070	0.12
OSRAM DULUX® D 18W	1200	18	67	100	220	220	800	0.12
OSRAM DULUX® D 26W	1800	26	69	105	325	315	540	0.10
DULUX D ES 16W	1120	16	70	85	235	235	800	0,12
DULUX D ES 23W	1700	23	74	90	340	340	540	0,1
OSRAM DULUX® T PLUS 13W	900	13	69	91	175	165	1070	0.12
OSRAM DULUX® T PLUS 18W	1200	18	67	100	225	220	800	0.12
OSRAM DULUX® T PLUS 26W ²⁾	1800	26.5	69	105	325	315	540	0.10
OSRAM DULUX® L 18W (XT)	1200	18	67	58	375	370	540	0.10
OSRAM DULUX® L 24W (XT)	1800	24	75	87	345	340	540	0.10
OSRAM DULUX® L 36W (XT)	2900	36	81	106	435	430	390	0.10
OSRAM DULUX® F 18W	1100	18	61	56	375	370	540	0.10
OSRAM DULUX® F 24W	1700	24	71	87	345	340	540	0.10
OSRAM DULUX® F 36W	2800	36	78	106	435	430	390	0.10
OSRAM CFL SQUARE® 16W	1050	16	66	103	195	195	890	0,12
OSRAM CFL SQUARE® 28W	2050	28	73	108	320	320	480	0,1
OSRAM CFL SQUARE® 38W	2735	38.5	71	110	430	430	390	0,1

1) In accordance with IEC 60901, measurements are taken at 220 V/50 Hz on the reference control gear. However, there is no change in the electrical lamp data for 230 V and 240 V supplies, provided suitable control gear is used.

2) Also for T CONSTANT

2.2.3 Inductive operation Series circuit

Series circuits (tandem circuits) are possible only for certain types of lamps in which the arc voltage does not exceed certain values (see 3.2.1 Permissible lamp/CCG combinations and system data, p. 47).

Measurement conditions according to IEC 60901:

- 220 V / 50 Hz supply voltage¹⁾
- Operation on reference gear
- Ambient temperature 25°C
- Lamps aged 100 hours
- Base-up position for OSRAM DULUX® S
- Horizontal position for OSRAM DULUX® L, F

Lamp reference	Luminous flux lm	Lamp Wattage W	Luminous efficacy lm/W	Arc Voltage V	Lamp current mA	Calibration current mA	Impedance Ω	Power factor
2x DULUX® S 5W	515	11	-	35	180	170	1070	0.12
2x DULUX® S 7W	820	13.7	-	47	160	170	1070	0.12
2x DULUX® S 9W	950	14.4	-	60	130	170	1070	0.12
2x DULUX® L 18W (XT)	2500	38	-	58	425	370	390	0.12
2x DULUX® F 18W	2300	38	-	56	425	370	390	0.12

¹⁾ In accordance with IEC 60901, measurements are taken at 220 V/50 Hz on the reference control gear. However, there is no change in the electrical lamp data for 230 V and 240 V supplies, provided suitable control gear is used.

2.2.4 Inductive operation Lead-lag circuit

With certain lamps in two-lamp inductive arrangements, a lead-lag circuit can be set up in which one of the two CCGs is combined with a series capacitor. For the capacitor data see 3.2.2 Compensation.

Circuit diagram available at www.osram.com.

2.3 Photometric data

2.3.1 Light colours

The light colours of the lamps are divided into three groups, each covering a particular colour temperature range.

Light colour	Colour temperature
Daylight	> 5000 K
Cool White	3300 - 5000 K
Warm White	< 3300 K

The light colour is determined by the x and y coordinates in the chromaticity table. For practical purposes, it is important to know the colour rendering properties of the lamps in addition to their light colour and colour temperature. These properties are defined by the (general) colour rendering index R_a .

The colour rendering index (computed using the CIE method) provides an indication of how non-luminous colours will appear when illuminated by the relevant light source.

Colour rendering is assessed by comparison with a Planckian radiator (< 5000 K) and normalised daylight (> 5000 K) of the same colour temperature. By definition, these radiators have the ideal colour rendering index of 100. Any deviation from this ideal is rated with values lower than 100.

The general colour rendering index R_a is the average value of eight different internationally standardised test colours (CIE).

There are various ranges for the R_a value, known as colour rendering groups:

R_a value	Group (according to EN 12464-1)	Characteristic
90 - 100	1A	Very good
80 - 89	1B	Very good
70 - 79	2A	Good
60 - 69	2B	Good
40 - 59	3	Satisfactory
20 - 39	4	Unsatisfactory

Note:

The colour perception of a non-luminous colour therefore always depends on the colour temperature of the illuminating lamp and colour rendering properties of this lamp.

Example:

Blue tones will always appear brighter in the light from a lamp with a daylight colour than in the light from a lamp with a warm white colour, even if both lamps have an R_a value of 100.

OSRAM DULUX® single-capped fluorescent lamps are available in LUMILUX® and LUMILUX® DE LUXE light colours. The most economical lighting is achieved with LUMILUX®. These light colours fall into colour rendering group 1B, which means they are ideal for most applications (including office and shop lighting, hotel and restaurant lighting, living rooms and outdoors). In places where colour rendering is a particular important factor (e.g., art galleries, museums, laboratories and graphical trades), OSRAM DULUX® lamps are also supplied in LUMILUX® DE LUXE light colours.

As group 1A lamps, these offer the best colour rendering. However, their luminous flux is lower than their LUMILUX® counterparts; therefore more lamps are needed to achieve the same lighting level. Ultimately, the choice of light colour depends on the specific application, room conditions and personal preference.

2.3.2 Colour specifications

Light colour Reference		Colour Temperature K	Colour rendering Group EN 12464-1	Colour rendering index CRI Ra
LUMILUX® DE LUXE				
950	LUMILUX® DE LUXE Daylight	5400	1A	≥ 90
940	LUMILUX® DE LUXE Cool White	3800	1A	≥ 90
930	LUMILUX® DE LUXE Warm White	3000	1A	≥ 90
LUMILUX®				
880	LUMILUX® Skywhite	8000	1B	80...89
865	LUMILUX® Daylight	6500	1B	80...89
840	LUMILUX® Cool White	4000	1B	80...89
830	LUMILUX® Warm White	3000	1B	80...89
827	LUMILUX INTERNA®	2700	1B	80...89
Special light colours¹⁾				
60	Red	-	-	-
66	Green	-	-	-
67	Blue	-	-	-

1) Lamps with chromaticity coordinates that do not lie in the vicinity of the reference radiators (Judd lines; see CIE calculation method) cannot, by definition, be assigned a colour temperature and hence cannot be assigned a colour rendering index.

2.3.3 Chromaticity coordinates tolerance fields

Chromaticity coordinates tolerance fields are ellipses in the chromaticity table which represent the permissible range for the relevant light colour. The tolerances are five threshold units for all light colours (LUMILUX®, LUMILUX® DE LUXE).

A threshold unit represents the minimum perceivable difference in colour between two lamps (see also IEC 60901 and IEC 60081).

2.3.4 OSRAM DULUX® light colours

Type	Luminous flux (lm) for light colour										
	LUMILUX®					LUMILUX® DE LUXE			SPECIAL LIGHT COLOURS		
	880 SKY-WHITE	865 Cool Daylight	840 Cool White	830 Warm White	827 INTERNA	950 Daylight	940 Cool White	930 Warm White	60 Red	66 Green	67 Blue
OSRAM DULUX® S 5W			257	257	257						
OSRAM DULUX® S 7W		385	405	405	405						
OSRAM DULUX® S 9W		565	600	600	600				400	800	200
OSRAM DULUX® S 11W		855	900	900	900						
OSRAM DULUX® S/E 7W			405	405	405						
OSRAM DULUX® S/E 9W			600	600	600						
OSRAM DULUX® S/E 11W			900	900	900						
OSRAM DULUX® D 10W			600	600	600						
OSRAM DULUX® D 13W			900	900	900						
OSRAM DULUX® D 18W			1200	1200	1200						
OSRAM DULUX® D 26W			1800	1800	1800						
OSRAM DULUX® D ES 16W			1120	1120	1120						
OSRAM DULUX® D ES 23W			1700	1700	1700						
OSRAM DULUX® D/E 10W			600	600	600						
OSRAM DULUX® D/E 13W			900	900	900						
OSRAM DULUX® D/E 18W ₃₎			1200	1200	1200						
OSRAM DULUX® D/E 26W ₃₎			1800	1800	1800						
OSRAM DULUX® T PLUS 13W			900	900	900						
OSRAM DULUX® T PLUS 18W			1200	1200	1200						
OSRAM DULUX® T PLUS 26W ₁₎			1800	1800	1800						
OSRAM DULUX® T/E PLUS 13W			900	900	900						
OSRAM DULUX® T/E PLUS 18W _{1) 3)}			1200	1200	1200						
OSRAM DULUX® T/E PLUS 26W _{1) 3)}			1800	1800	1800						
OSRAM DULUX® T/E PLUS 32W _{1) 3)}			2400	2400	2400						
OSRAM DULUX® T/E PLUS 42W _{1) 3)}			3200	3200	3200						
OSRAM DULUX® T/E 11W HE ₂₎			810	810							
OSRAM DULUX® T/E 14W HE ₂₎			1050	1050							
OSRAM DULUX® T/E 17W HE ₂₎			1250	1250							
OSRAM DULUX® L 18W ₃₎			1200	1200	1200	750	750	750			
OSRAM DULUX® L 24W ₃₎			1800	1800	1800	1200	1200	1200			550
OSRAM DULUX® L 36W ₃₎	2610	2755	2900	2900	2900	2030	2320	2320			
OSRAM DULUX® L 40W ₁₎	3000	3325	3500	3500	3500	2350					
OSRAM DULUX® L 55W _{1) 3)}	4100	4550	4800	4800	4800	3000	3610	3610			
OSRAM DULUX® L 80W ₁₎	5600	6000	6000	6000							
OSRAM DULUX® L 16W HE			1500	1500							
OSRAM DULUX® L 22W HE			2055	2055							
OSRAM DULUX® L 26W HE			2470	2470							
OSRAM DULUX® L 28W HE			2700	2700							

Type	Luminous flux (lm) for light colour										
	LUMILUX®					LUMILUX® DE LUXE			SPECIAL LIGHT COLOURS		
	880 SKY-WHITE	865 Cool Daylight	840 Cool White	830 Warm White	827 INTER-NA	950 Daylight	940 Cool White	930 Warm White	60 Red	66 Green	67 Blue
OSRAM DULUX® L 18W SP			1200	1200							
OSRAM DULUX® L 24W SP			1800	1800							
OSRAM DULUX® F 18W			1100	1100	1100						
OSRAM DULUX® F 24W			1705	1705	1705						
OSRAM DULUX® F 36W			2810	2810	2810						
CFL SQUARE® 16W				1050*	1050						
CFL SQUARE® 28W				2050*	2050						
CFL SQUARE® 38W				2735*	2735						

*) Light colour 3500K
 1) Also for CONSTANT models
 2) Values for an ambient temperature of 25°C, maximum values at ambient temperature of 35°C
 3) Also valid for XT models

2.3.5 Factors affecting colour consistency

There are a number of factors that affect colour consistency and the perception of the light colour of compact fluorescent lamps.

Iridescence

Iridescence is a property of some anodised reflector finishes which results in a „rainbow“ effect when use in conjunction with tri-chrome phosphors. Since all OSRAM DULUX® lamps contain tri-chrome phosphors, this effect caused by the reflector may be wrongly ascribed to the lamps as „different light colours“.

Ambient temperature

The light colour of tri-chrome phosphors changes slightly as the ambient temperature changes because of the relationship between luminous flux and temperature. This is apparent in applications in which, say, open ceiling light fittings are installed close to air-condition outlets. In such cases, the light colour may be slightly different from that of luminaires located further away. This effect can be minimised by coordinating the air-conditioning system with the lighting system.

Manufacturing tolerances

There may be minimal differences in the light colours of lamps from different manufacturers. In applications in which colour consistency is a critical factor, all the lamps in a particular zone should come from the same manufacturer and should all be replaced together. If lamps are replaced individually there may be differences in light colour.

Dimming

When fluorescent lamps are dimmed there is a slight reduction in colour temperature. The colour temperature of a fully dimmed OSRAM DULUX® L 36 W lamp, for example, is around 150 K lower than that of an undimmed lamp. The colour difference appears greater to the eye due the considerable differences in luminance. Even greater differences may occur temporarily if there is a sharp change in the dimmer setting (see 4.7 and 5.1.4).

Ageing

Generally speaking, there are no changes in colour temperature or shifts in chromaticity coordinates in the course of a lamp's service life. However, lamps do suffer a drop in luminous flux as they age (see 2.4) and it is the resulting difference in luminance between an old lamp and a new lamp that gives the impression of a change in colour temperature.

2.3.6 Spectral distribution

The relative spectral power distribution is determined mainly by the light colour, whereas the different models and wattages have a negligible effect.

The spectral distributions shown below are therefore typical of all OSRAM DULUX® lamps for the relevant light colour (relative values).

The spectral irradiance distributions refer to an illuminance of 1000 lx. The advantage here is that the absolute values of any illuminance can be found simply by dividing by 1000 lx:

The spectral intensities are condensed into wavelength ranges of 5 nanometres. In other words, irrespective of the actual distributions, the values given have been integrated over 5 nm. This corresponds to the standard applied to all calculations of consequential results (such as colour and colour rendering).

The spectral power distribution of OSRAM DULUX LUMILUX® and LUMILUX® DE LUXE lamps can be found in the latest edition of the Lighting Program.

Light colours

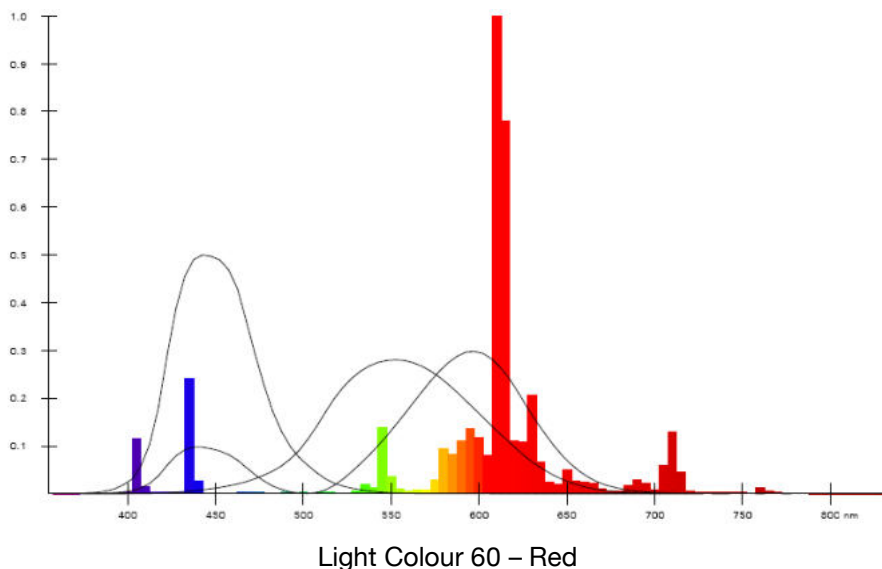

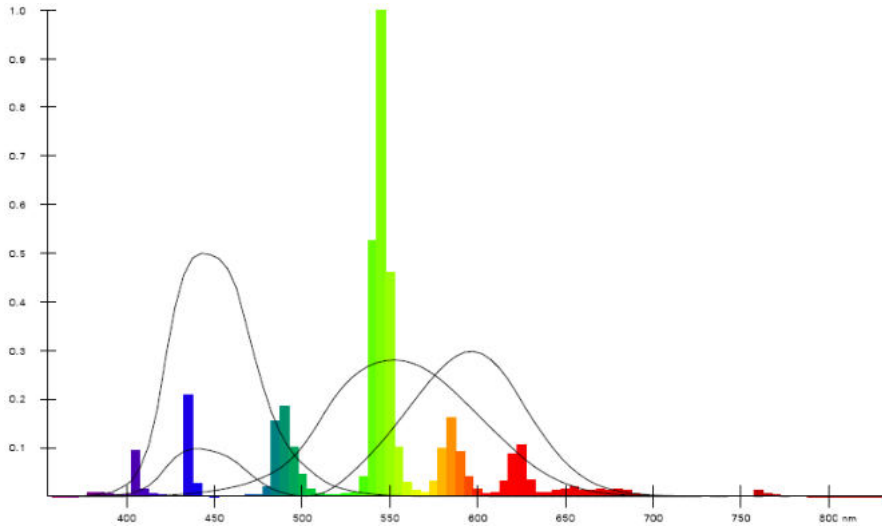

Light colour 66 – Green

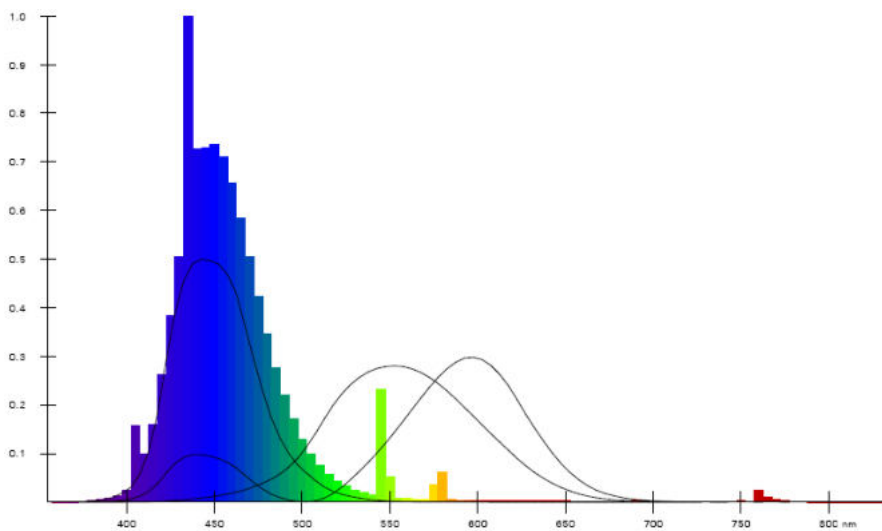

Light colour 67 - Blue

2.3.7 Radiation components in the ultra-violet range:

Ultra-violet radiation can have desirable effects (e.g., tanning) and undesirable ones (e.g., sunburn) on the human body. The intensity of these effects depends on the irradiance level and the period of exposure.

In the case of lamps intended for general lighting applications, lamp and light fitting manufacturers must ensure that there is no possibility of any harmful effects even under high illuminance levels over a full day.

All OSRAM DULUX® lamps comply with the safety limits of UV and Blue light components set by the IEC 62471 Safety Standard – Photo-biological Safety of Lamps and Lamp Systems.

→ For spectral radiation values, consult www.osram.com

If light-sensitive materials are exposed to this light for relatively long periods, there may be some change in colour (e.g., bleaching). In OSRAM DULUX® lamps this effect is caused primarily by UV-A radiation. Lamps with low UV-A components or low illuminance levels should therefore be chosen for illuminating light-sensitive materials.

2.3.8 Radiation components in the infra-red range

Fluorescent lamps emit radiation at wavelengths which are also used for infra-red transmissions. Since the IR receivers used for televisions, wireless headphones and sound transmission systems, for example, are often not sufficiently selective there may be interference in the IR system, particularly with lamps operated by electronic control gear, if light or optical radiation from the lighting system enters the IR receiver. The light emitted by a fluorescent lamp is essentially modulated at twice the operating frequency (50 to 250 kHz in the case of electronic control gear and 100 or 120 Hz in the case of conventional control gear). Interference may occur if the useful signal is also operating in this frequency range.

Audio transmission

For further information on this topic please consult the OSRAM QUICKTRONIC® technical guides or visit www.osram.com/quicktronic.

IR remote control

Interference-free operation is possible with systems that work with a sufficiently high carrier frequency (400 to 1500 kHz). If interference occurs in systems or equipment operating at a lower carrier frequency, it is best to move the IR receiver as far as possible away from the radiation footprint of the lamp or shield it from direct light.

For further information on this topic please consult the OSRAM QUICKTRONIC® technical guides or visit www.osram.com/quicktronic.

Electronic merchandise security systems

In many shops nowadays, merchandise such as CDs and clothing is protected against theft by electronic security systems. These systems typically operate with resonances in the kHz range. If the operating frequency is between 30 kHz and 150 kHz it may lead to interference. Such interference can be avoided by increasing the distance between the light fittings and the transmitting/receiving system.

For further information on this topic please consult the OSRAM QUICKTRONIC® technical guides or visit www.osram.com/quicktronic.

2.3.9 Luminous intensity distribution charts

The luminous intensity distributions of OSRAM DULUX® lamps depend on the plane in which measurements are taken. For assessment and planning purposes, it is therefore not sufficient simply to consider the average of all planes. Measurements of the luminous intensity distribution in three selected planes are adequate.

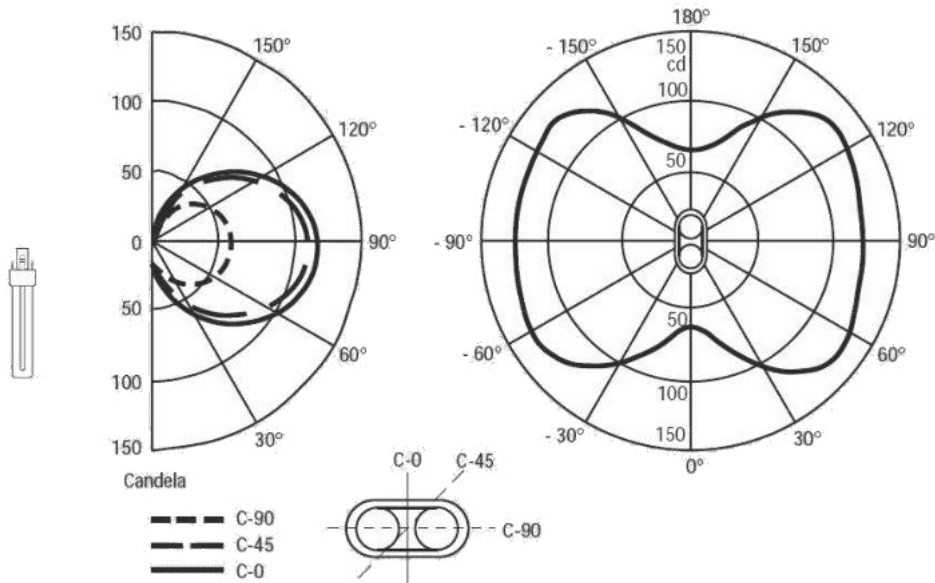

OSRAM DULUX® S, OSRAM DULUX® S/E, OSRAM DULUX® L, L SP, L XT and L HE Axial and radial luminous intensity distribution referred to 1000 lm, Base-up position

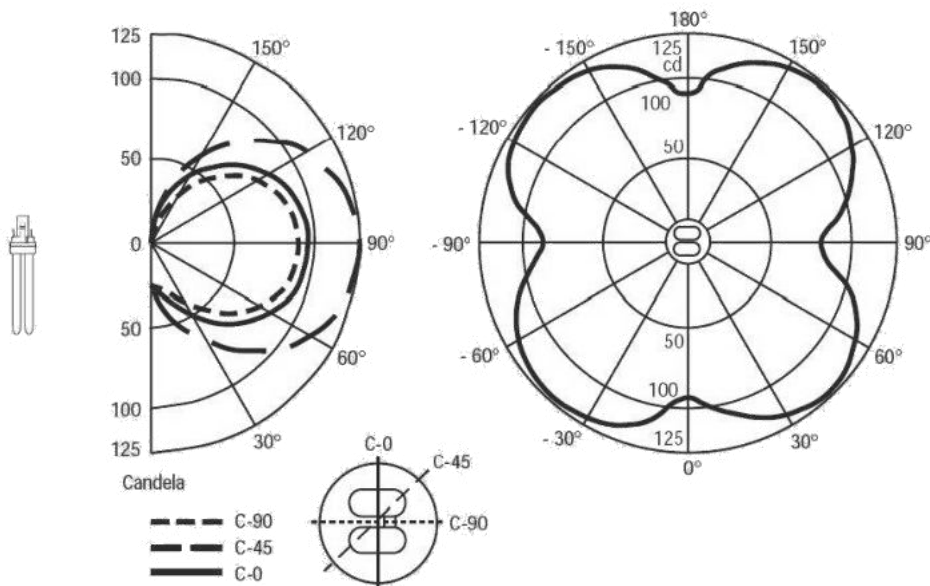

OSRAM DULUX® D, D ES, OSRAM DULUX® D/E and D/E XT Axial and radial luminous intensity distribution referred to 1000 lm, Base-up position

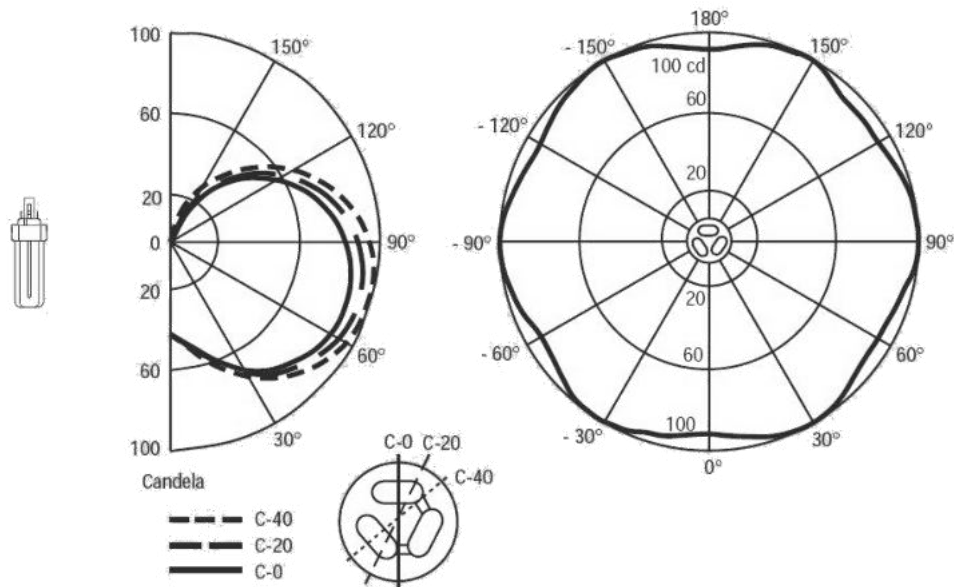

OSRAM DULUX® T PLUS, T CONSTANT, OSRAM DULUX® T/E PLUS, T/E XT, T/E HE and T/E CONSTANT Axial and radial luminous intensity distribution referred to 1000 lm, Base-up position.

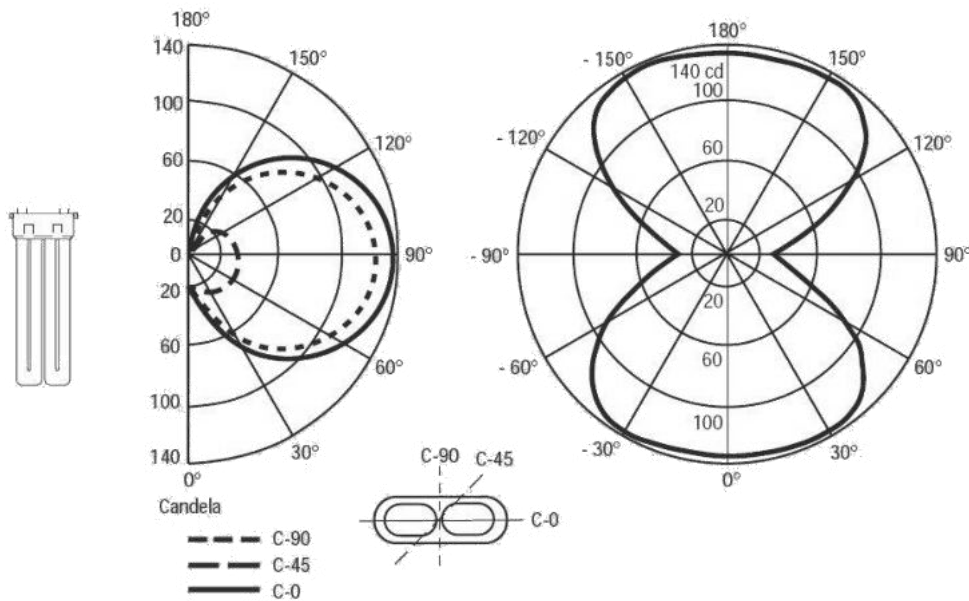

OSRAM DULUX® F, Axial and radial luminous intensity distribution referred to 1000 lm, Base-up position

2.3.10 Luminance of OSRAM DULUX® lamps

Lamp Average luminance ¹⁾	cd/cm ²
OSRAM DULUX® S 5W	2.5
OSRAM DULUX® S and S/E 7W	2.6
OSRAM DULUX® S and S/E 9W	2.8
OSRAM DULUX® S and S/E 11W	2.7
OSRAM DULUX® D and D/E 10W	4.0
OSRAM DULUX® D and D/E 13W	4.0
OSRAM DULUX® D and D/E 18W ³⁾	4.5
OSRAM DULUX® D and D/E 26W ³⁾	5.5
OSRAM DULUX® D ES 16W	4.3
OSRAM DULUX® D ES 23W	4.3
OSRAM DULUX® T PLUS and T/E PLUS 13W	4.2
OSRAM DULUX® T PLUS and T/E PLUS 18W ³⁾	4.7
OSRAM DULUX® T PLUS and T/E PLUS 26W ^{2) 3)}	6.0
OSRAM DULUX® T/E PLUS 32W ^{2) 3)}	6.5
OSRAM DULUX® T/E PLUS 42W ^{2) 3)}	7.0
OSRAM DULUX® T/E 11W HE	2.9
OSRAM DULUX® T/E 14W HE	2.9
OSRAM DULUX® T/E 17W HE	2.9
OSRAM DULUX® L 18W ³⁾	2.1
OSRAM DULUX® L 24W ³⁾	2.1
OSRAM DULUX® L 36W ³⁾	2.8
OSRAM DULUX® L 40W ²⁾	2.3
OSRAM DULUX® L 55W ^{2) 3)}	3.2
OSRAM DULUX® L 80W ²⁾	3.2
OSRAM DULUX® L 16W HE	in preparation
OSRAM DULUX® L 22W HE	in preparation
OSRAM DULUX® L 26W HE	in preparation
OSRAM DULUX® L 28W HE	1.9
OSRAM DULUX® F 18W	2.4
OSRAM DULUX® F 24W	2.5
OSRAM DULUX® F 36W	3.0
CFL SQUARE® 16W	in preparation
CFL SQUARE® 28W	in preparation
CFL SQUARE® 38W	in preparation

1) For colours 840 LUMILUX: Cool White, 835 LUMILUX: Cool White, 830 LUMILUX: Warm White and 827 LUMILUX INTERNA-

2) Also for CONSTANT models

2) Also for XT models

2.4 Lamp life and maintenance

2.4.1 Definitions

There are several definitions of lamp life, which are applied differently depending on the type of lamp, the lamp manufacturer and the geographical region. The most important definitions for compact fluorescent lamps are given below.

Lamp life is the period of time during which a lamp can be operated until it is unusable (electrical failure, light loss / insufficient light output).

Average rated lamp life (B50) is the average value of the life values of individual lamps operated under standardized conditions (50 % failure). In other words, this is the operation time at which for a standardized 3-hour switching cycle (165 minutes on/15 minutes off in accordance with IEC 60901) 50 % of a sample population of lamps have failed.

OSRAM DULUX® lamps	Average rated lamp life (B50)
OSRAM DULUX® D/E XT, T/E XT, L XT with ECG (BAT)	36,000 h
OSRAM DULUX® S/E, D/E, T/E PLUS*, T/E HE, T/E CONSTANT*, L, L HE, L CONSTANT and F with ECG (BAT)	20,000 h
OSRAM DULUX® S, D, D ES, T PLUS*, T CONSANTNT and F with CCG	10,000 h
CFL SQUARE® with ECG (BAT) or CCG	10,000 h

* Different lifetime for single lamps: T/E PLUS & T/E CONSTANT 42W: 13,000 h, T PLUS 13W: 3,200 h, T PLUS 18W: 3,900 h

Because chemical changes in the phosphor during the lamp life, the luminous flux of the lamp decreases as the lamp ages. The term “maintenance” is used to indicate how well the luminous flux is retained throughout the life of the lamp.

2.4.2 Maintenance for OSRAM DULUX® lamps

For further information, please consult <http://catalog.myosram.com>.

2.4.3 Mortality charts of OSRAM DULUX® lamps

For further information, please consult <http://catalog.myosram.com>.

2.4.4 Effect of switching operations on lamp life

Average rated lamp life in CCG or ECG operation is based on a switching cycle of 165 minutes on and 15 minutes off in accordance with IEC 60901.

In CCG operation, if there are fewer switching operations than under these standard conditions, average rated lamp life will be increased. If, however, the lamp is switched on and off more often, it will not last as long.

If an electronic control gear designed for pre-heat start according to IEC 60901 is used, the number of possible switching operations is greatly increased compared to operation with a CCG, due to an optimum electrode preheating.

Note: Using a warm start designed ECG build upon an older technology, it is possible that after the lamps have been switched off, it is necessary to wait a certain time, before switching on the lamps again, to ensure a reliable warm restart of the lamps (see ECG specifications).

In any case, using the modern types of ECG, **best available technology (BAT)**, it is not necessary to wait a certain time anymore, there is no restriction on switching cycles or switching off time periods affecting the lamp life, under normal operation conditions.

If an electronic control gear designed for an instant start is used, the number of possible switching cycles is strongly decreased compared to an operation with warm start ECG. For an operation with instant start ECG, a maximum of 2 switching cycles per day is recommended, without affecting the lamp life.

3 Circuits

3.1 Operation with electronic control gear (ECG)

OSRAM DULUX® S/E, D/E, and T/E PLUS with four-pin bases, T/E HE, XT and CONSTANT lamps and OSRAM DULUX® L 40, 55 W and 80 W lamps (including XT and CONSTANT types) have been designed to operate with electronic control gear only. OSRAM DULUX® L and F 18, 24, 36 W and the CFL SQUARE® four-pin can be operated with either electronic or magnetic control gear.

To ensure safe operation of both, the lamp and the ECG, the wiring between the outputs of the ECG and the terminals on the lamp holder(s) must be correct. This applies not only to two-lamp arrangements but also to single-lamp configurations. Certain cables from the ECG to the lamp or lamps („hot ends“) should be kept as short as possible to avoid issues with radio interference. This means one should choose an asymmetrical mounting location in the light fitting to increase the length of the low potential cables if you can thereby shorten the lamp cables carrying high potential.

The correct circuit layout is generally printed on the ECG casing. Check with the ECG manufacturer to establish which terminals are the „hot ends“. This information may be shown on the casing (e.g. „keep wires x and y short“).

With dimmable ECGs the length of the control cable(s) and the way in which they are laid also play a role. For further information on this topic please consult the OSRAM QUICKTRONIC® technical guides or visit www.osram.com/quicktronic.

Another important factor with ECGs is the t_c measuring point on the casing. The temperature indicated here must not be exceeded during operation otherwise the unit will fail prematurely.

A prominent characteristic of electronic control gear, and one that applies to most units (see information on the casing) is whether or not it is suitable for dc operation (for approximately the same rms values for AC and DC). In many cases, a DC-compatible ECG can also be used in emergency lighting systems. The relevant regulations governing emergency lighting must be observed. QUICKTRONIC® control gear from OSRAM is suitable for emergency lighting in accordance with DIN VDE 0108-100 / EN50172.

Information from the manufacturers regarding circuits (circuit diagrams) can generally be found on the casing cover.

For further information on permissible lamp/ECG combinations and system data please consult the latest edition of the OSRAM Lighting Programme or use the lamp/ECG configurator on www.osram.com/quicktronic.

3.2 Operation with conventional control gear (CCG)

OSRAM DULUX® S, D, D ES, T PLUS and CFL SQUARE® lamps with a two-pin base have an integrated glow starter and are suitable for CCG operation. OSRAM DULUX® L, F, CFL SQUARE® lamps with four-pin bases do not have an integrated glow starter and require an external starter (see 6.3 Starters) if they are to be operated with conventional control gear (16 W to 38 W).

It is recommended that only suitable lamp/CCG combinations for single and series circuits are used. The system data (lamp + CCG) is shown in the table in 3.2.1.

Circuit diagrams are included in the current OSRAM Lighting Program.

3.2.1 Permissible lamp/CCG combinations and system data

OSRAM DULUX® lamps should be operated only with suitable control gear. If the control gear has a too high rating the lamps will be overloaded by an excessively high current, which may shorten their life and overheat the lamp cap. If, however, the gear has a too low rating the lamps will not be supplied with enough current; this may damage the lamp and therefore again shorten its life. Normally, if the lamps are underloaded in this way, an excessive increase in lamp voltage will cause the starter to switch.

The following table provides a summary of suitable magnetic control gear.

Lamp	CCG
OSRAM DULUX® S 5 W	5-11W / KLL (155-180 mA)
OSRAM DULUX® S 7 W	5-11W / KLL (155-180 mA)
OSRAM DULUX® S 9 W	5-11W / KLL (155-180 mA)
OSRAM DULUX® S 11 W	5-11W / KLL (155-180 mA)
2x OSRAM DULUX® S 5 W	10-13W / KLL (165-180 mA) ¹⁾
2x OSRAM DULUX® S 7 W	10-13W / KLL (165-180 mA) ¹⁾
2x OSRAM DULUX® S 9 W	10-13W / KLL (165-180 mA) ¹⁾
OSRAM DULUX® D 10 W	10-13W / KLL (165-180 mA)
OSRAM DULUX® D 13 W	10-13W / KLL (165-180 mA)
OSRAM DULUX® D 18 W, D ES 16W	18W / KLL (220 mA)
OSRAM DULUX® D 26 W, D ES 23W	24-26W / KLL (315 mA) also 18W/LLp (370 mA) ²⁾
OSRAM DULUX® T PLUS 13W	10-13W / KLL (165-180 mA)
OSRAM DULUX® T PLUS 18W	18W / KLL (220 mA)
OSRAM DULUX® T PLUS 26W ₃₎	24-26W / KLL (315 mA) also 18W/LLp (370 mA) ²⁾
OSRAM DULUX® L 18 W	18W / LLp (370 mA)
OSRAM DULUX® L 24 W	24-26W/KLL (315 mA) also 18W / LLp (370 mA) ²⁾
OSRAM DULUX® L 36 W	36W / LLp (430 mA)
2 x OSRAM DULUX® L 18 W	36W / LLp (430 mA) ²⁾
OSRAM DULUX® F 18 W	18W / LLp (370 mA)
OSRAM DULUX® F 24 W	24-26W / KLL (315 mA) also 18W / LLp (370 mA) ²⁾
OSRAM DULUX® F 36 W	36W / LLp (430 mA)
2 x OSRAM DULUX® F 18 W	36W / LLp (430 mA) ²⁾

1) While **2 x OSRAM DULUX- 5** and **7 W** can be operated in series with suitable control gear on 200 V and higher, a supply voltage of at least 220 V is needed for **2 x OSRAM DULUX- 9 W** in series.
 Conventional control gear for L 13 W can also be used for **2 x OSRAM DULUX- 5**, **2 x 7** and **2 x 9 W** in series provided a preheating current of 240 mA is maintained under limited conditions.

Control gear for series circuits must not be used for **OSRAM DULUX- S** lamps in single circuits.

2) With this combination, however, there are considerable restrictions regarding the life of the lamps.

3) Also for CONSTANT type

It is not possible to connect 2 x OSRAM DULUX- D or OSRAM DULUX- T in series using a choke. It is not possible to connect 2 x OSRAM DULUX- S 11 W, 2 x OSRAM DULUX- L and F 24 W and 36 W in series because the arc voltage is too high.

3.2.2 Compensation

The need to compensate for the reactive power depends on the technical connection conditions of the electricity supply company. Compensation for reactive power is covered by the EN 61000-3-2 standard (see 9.1.2). Compensation can be provided on an individual basis per luminaire, for groups of luminaires or at a central location.

Generally, electricity consumption should involve a power factor of between $\cos \varphi = 0.9$ (capacitive) and 0.8 (inductive). Depending on the type of system, which obviously comprises more inductive loads than just low-voltage discharge lamps, one has to decide which type of compensation should be used:

- Individual compensation per luminaire
- Group compensation
- Central compensation.

The capacitor must be connected in parallel with the mains terminals. Compensation with a series capacitor is possible in certain circumstances but, except in the case of OSRAM DULUX® L 36 W, not recommended, since the permissible current and power limits cannot be reliably maintained if the permissible tolerances for the capacitors, control gear and lamps are fully utilized.

The limits for exploiting the permitted tolerances (close tolerance) for the capacitance of the series capacitor (IEC 61049) and the impedance of the choke (IEC 60920) or lamps cannot be reliably met.

Mains parallel capacitors are not permitted in existing audio-frequency remote control systems operating at high frequency. They are suitable only for compensation with series capacitors. Compensation is not required if the lamps are operated with electronic control gear.

The following table shows the capacitance values for the various lamps.

	Parallel compensation1) 230V/50Hz µF	Series compensation2) 450V-480V/50Hz µF
OSRAM DULUX® S 5 W	2.2	–
OSRAM DULUX® S 7 W	2.1	–
OSRAM DULUX® S 9 W	2.0	–
OSRAM DULUX® S 11 W	1.7	–
2x OSRAM DULUX® S 5 W	1.9	–
2x OSRAM DULUX® S 7 W	1.6	–
2x OSRAM DULUX® S 9 W	1.2	–
OSRAM DULUX® D 10 W	2.2	–
OSRAM DULUX® D 13 W	1.8	–
OSRAM DULUX® D 18 W, D ES 16W	2.2	1.7
OSRAM DULUX® D 26 W, D ES 23W	3.2	2.5 ₃₎
OSRAM DULUX® T PLUS 13 W	1.8	–
OSRAM DULUX® T PLUS 18 W	2.3	1.7
OSRAM DULUX® T PLUS 26 W (CONSTANT)	3.3	2.5 ₃₎
OSRAM DULUX® L 18 W	4.2	2.7
OSRAM DULUX® L 24 W	3.6	2.7

	Parallel compensation1) 230V/50Hz µF	Series compensation2) 450V-480V/50Hz µF
OSRAM DULUX® L 36 W	4.4	3.4
2 x OSRAM DULUX® L 18 W	3.4	3.4
OSRAM DULUX® F 18 W	4.2	2.7
OSRAM DULUX® F 24 W	3.6	2.7
OSRAM DULUX® F 36 W	4.4	3.4
2 x OSRAM DULUX® F 18 W	3.4	3.4
OSRAM CFL SQUARE® 16W	2.0	–
OSRAM CFL SQUARE® 28W	3.0	–
OSRAM CFL SQUARE® 38W	4.5	–

1) For Cos phi = 0,95; Dielectric strength of the capacitors 250 V ac; Capacitance tolerance ±10%

2) For Cos phi = at least 0,95; Dielectric strength of the capacitors 450 V ac

To guarantee the prescribed operating and preheating values, capacitors and control gear with narrow tolerances (± 2 % and ± 1,5 % respectively) are needed for series compensation. Please refer to the catalogues of the major manufacturers.

3) 24-26 W CCG for CFLs (2,7 µF for 18 W CCG for fluorescent lamp).

3.2.3 Operation of OSRAM DULUX® S/E, D/E und T/E PLUS with external starter and CCG

OSRAM DULUX® S, D, T PLUS lamps and the CFL SQUARE® lamp (with two-pin bases) have been designed specifically for operation with conventional control gear. Integrated in their bases is a specially developed glow starter that has been adapted to the particular requirements of these compact fluorescent lamps.

OSRAM DULUX® S/E, D/E, T/E PLUS, T/E HE, T/E XT, T/E CONSTANT, DULUX L (40W, 55W, 80W), L XT, L HE and L CONSTANT with four-pin bases are intended for operation with electronic control gear, and hence without a starter.

For this reason, this mode of operation (4-pin lamps with external starter) is not recommended or supported by OSRAM.

Exception: OSRAM CFL SQUARE® lamps 16W, 28W, 38W with the 4-pin base, are intended with electronic control gear, and hence without a starter. Generally it is possible to operate OSRAM CFL SQUARE® lamps 16W, 28W, 38W with the 4-pin base with conventional control gear and an external starter under normal operating conditions. OSRAM Starter ST 111 Longlife is released to operate CFL SQUARE® lamps 16W, 28W, 38W with the four-pin base.

3.3 Operating on dc sources

Compact fluorescent lamps cannot be operated from DC sources with conventional control gear.

Most ECGs are DC-compatible. The DC voltage must be around the rated mains voltage of 230 V. See information supplied by ECG manufacturers.

Changeover units (emergency luminaires with internal changeovers, known as battery packs) are offered. These feed the lamps directly on emergency power supply and interrupt the system circuit between the CCG or ECG and the lamps. These changeover units for emergency lighting must reliably comply with the parameters for preheating and for operating the lamps. If operated continuously, control gear for emergency lighting can generate a DC component that may damage the lamp electrodes (underload operation of the lamps). This underload operation with a DC component causes electrophoresis in the lamp. As a result, the mercury migrates from one electrode to another if the lamp is operated continuously, which causes one end of the lamp to turn red. This greatly reduces the life of the lamp. In this case, OSRAM therefore cannot guarantee the life of the lamp.

Another factor with negative effect on lamp life in emergency operation mode, is often a higher current crest factor, and also due to a insufficient energy supply of the emergency unit, a cold start of the lamp.

3.3.1 Compact fluorescent lamps in emergency lighting

Requirements for emergency lighting

Emergency lighting applications often supply a significantly reduced discharge current with respect to the specified discharge current without auxiliary coil heating. This is done to extend the operational time when the system is operated on batteries.

From the description of dimmed fluorescent lamp operation it is well known that if a fluorescent lamp is operated below 80% of the standardized test current auxiliary coil heating is necessary in order to prevent an increase of the cathode fall voltage, which will lead to sputtering on the coil and early lamp failure.

If a lamp is operated in the so called dimmed zone of discharge current below 80% of the test current without any coil heating, lamp life will be reduced by a higher factor the lower the discharge current to test current ratio gets. The diagram below shows a rough estimate of operational time which can be expected.

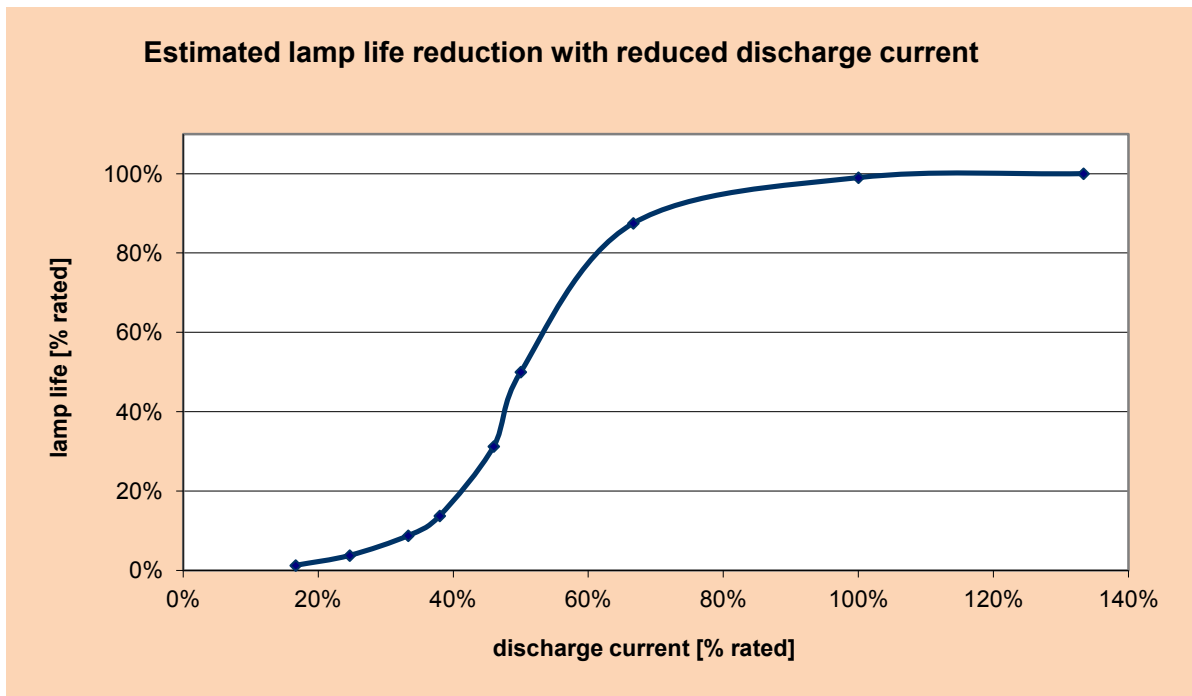

If a lamp is operated in the dimmed zone without auxiliary heating, the coil will be damaged as explained above. If the operation in the dimmed zone is only for a limited time interval and the lamp is then again operated according to the specification, the damage can be partly corrected. Unfortunately the coil cannot recover completely from the damage. The more often dimmed operation without coil heating happens the more lamp life is further reduced. It is very difficult to estimate this lamp life reduction because it strongly depends on the time schedule of normal operation (i.e. according to the specification) and dimmed operation without coil heat.

3.4 Operation with motion detectors and light sensors

It is basically possible to operate OSRAM DULUX® compact fluorescent lamps with pin bases in conjunction with motion detectors and light sensors. Bear in mind that in these arrangements the lamps operate only for short periods before switching off again, so the run-up time for light output (the time the lamp takes to reach 100 % luminous flux) and the reduction in lamp life (old ECG technology) due to the high number of switching operations are factors that must be taken into account. (see 2.4.4)

CCG-operated lamps should not be used in applications with extremely frequent on/off switching. Instead, only compact fluorescent lamps for ECG operation should be used. The ECG should be selected to ensure optimum lamp starting every time. Not all types of ECGs are suitable for a very frequent switching, like it is the case by motion detectors. Only warm start ECGs are suitable. Even here some models need a certain time out after switching off, to ensure a warm re-start of the lamp with correct preheating by the next switch on.

It is necessary to refer to the technical data sheet of the ECG or request the information about the suitability of the ECG for very frequent switching by the manufacturer.

Stand-by operating modes are ideal for such applications. In stand-by mode the light is dimmed when it is not needed. This avoids unnecessary switching operations and saves energy. Because the light is never fully switched off there is always a certain amount of light available for people to find their way around. Full light is available instantly, with no pre-heating delay. Typical applications for stand-by mode include all those with frequent on/off switching, such as stairwells, corridors and underground garages. Particularly if the light is controlled with motion detectors or time switches.

3.5 Dimensioning of automatic circuit breakers

Information on the maximum permitted number of luminaires per automatic circuit breakers can be found in the OSRAM Lighting Program.

4 Operating characteristics

4.1 Start-up characteristics

4.1.1 Single circuit, inductive operation

For OSRAM DULUX® compact fluorescent lamps the average starting times in inductive mode are: 1.5 to 3.0 seconds for a supply voltage of 230 V and an ambient temperature of 25°C. At low temperatures and/or if the supply voltage falls 10 % below its rated value of 230 V there will be a considerable increase in the starting times. OSRAM DULUX® T 26 W CONSTANT (amalgam lamps) should be ignited and operated only at the optimum supply voltage (230 V) and never below 5°C. The table shows starting time values measured according to the description in IEC 60901. In real applications with common magnetic ballasts deviations from the figures below are possible.

Average ignition time at the rated voltage 230 V (s)					
Type	Power	25°C	0°C	-10°C	-20°C
OSRAM DULUX®S	5 W	2	2	2	2
	7 W	2	3	3	3
	9 W	2	3	>10	>10
	11 W	2	2	2	5
OSRAM DULUX®D	10 W	2	2	3	3
	13 W	2	2	2	-
	18 W	2	2	2	3
	26 W	3	3	3	-
OSRAM DULUX®D ES	16 W	2	2	2	3
	23 W	3	3	3	-
OSRAM DULUX®T	13 W	3	>10	>10	>10
	18 W	2	>10	-	-
	26 W	2	3	>10	-
OSRAM DULUX®T CONSTANT	26 W	3	>10	-	-
OSRAM DULUX®L (XT)	18 W	1	2	2	3
With suitable starter	24 W	2	4	5	6
	36 W	3	4	4	5
OSRAM DULUX®L SP	18 W	*)	*)	*)	*)
With suitable starter	24 W	*)	*)	*)	*)
OSRAM DULUX®F	18 W	*)	*)	*)	*)
With suitable starter	24 W	*)	*)	*)	*)
	36 W	*)	*)	*)	*)
OSRAM CFL SQUARE®	16 W	*)	*)	*)	*)
	28 W	*)	*)	*)	*)
	38 W	*)	*)	*)	*)

*) in preparation

4.1.2 Series circuit, inductive operation

The average starting times are also increased in the case of series circuits in inductive mode.

Amalgam lamps are not suitable for series circuits in inductive or capacitive operation.

4.2 Starting at low temperatures

Some of the models in the OSRAM DULUX® compact fluorescent lamp range are ideal for use in outdoor lighting systems where temperatures during the cold season may be 0 °C or below. Some models ignite quite readily even at those low temperatures, and some have critical ignition limits. When selecting lamps and light fittings, therefore, the temperature factor should also be considered.

The following table shows the low temperature ranges at which various models with two-pin bases will still start reliably in conjunction with conventional control gear.

Operating conditions:

- 230 V/50 Hz supply voltage
- Base-down position

Reliable ignition at temperatures down to:

Lamp	5°C	0°C	-5°C	-10°C	-15°C	-20°C
OSRAM DULUX® S		7 W, 9W				5 W, 11W
OSRAM DULUX® D		26W		13W, 18W		10W
OSRAM DULUX® D ES *			16W, 23W			
OSRAM DULUX® T	18W, 26W	13W				
OSRAM DULUX® T CONSTANT	26W					
OSRAM DULUX® L (XT)				24W, 36W		18W
OSRAM DULUX® L SP					24W, 36W	18W
OSRAM DULUX® F				24W, 36W		18W
OSRAM CFL SQUARE® *						

*) in preparation

With electronic control gear, the temperature range for reliable ignition is extended downwards, even for critical models. Irrespective of the ambient temperature, the lamp is always supplied with the optimum ignition pulse. Repeated attempts to ignite the lamp at low temperatures will damage the lamp. With ECGs this situation is generally avoided.

The temperature range in which an ECG will reliably ignite a lamp depends on the ECG itself. Consult the ECG manufacturer for more details. Depending on the particular lamp and the particular ECG used, OSRAM QUICKTRONIC® units can ignite compact fluorescent lamps at temperatures as low as -15°C or -25°C.

Reliable ignition (inductive operation) of the lamps (at low temperatures according to the above table) takes place at rated voltage within a period of 60 s. There is a chance that these ignition times will increase as the lamps age (ageing of the starters) or if moisture penetrates the light fitting. In capacitive operation a longer ignition time than with inductive operation must be expected.

In the case of inductive operation with reduced voltage, the temperature threshold for reliable ignition of the lamps is raised. This longer ignition time must be taken into account.

4.3 Run-up behaviour

The start-up behaviour of an OSRAM DULUX® lamp depends on more factors: e.g. type of the lamp, type of the control gear (whether ECG or CCG), ambient temperature, burning position, off time, volume and the construction of the light fitting and others.

Below are examples of run-up diagrams of different DULUX® lamps in different burning positions (free burning).

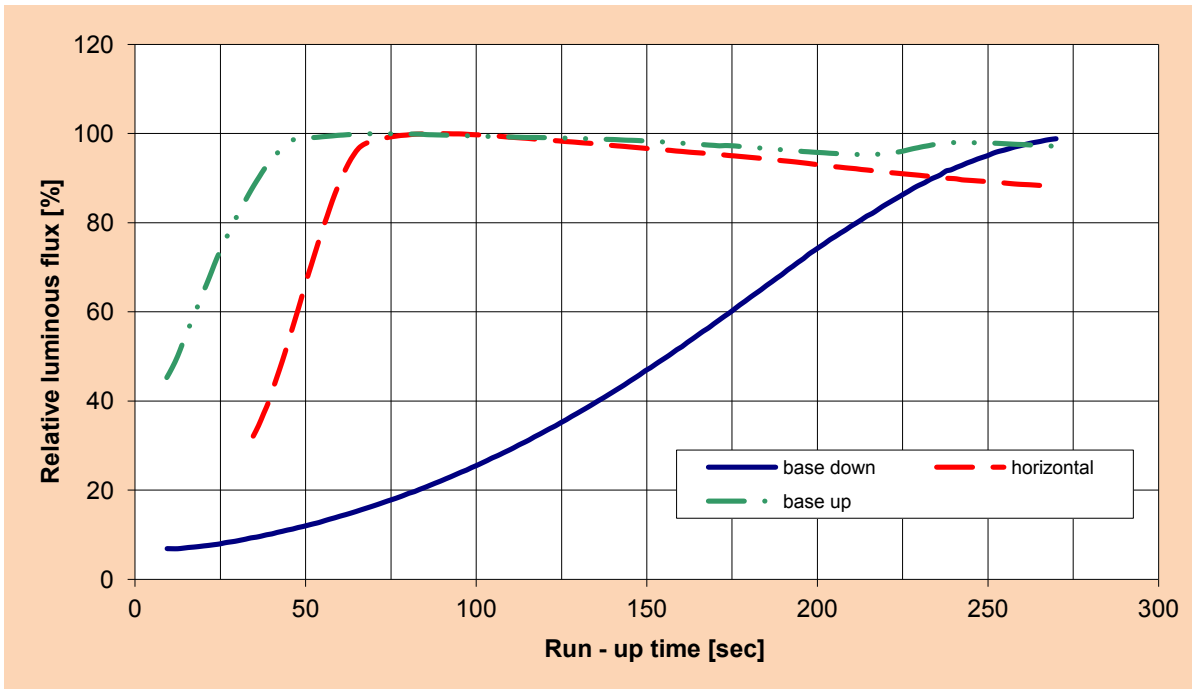

Typical run-up behavior of OSRAM DULUX® lamps (except special models) in CCG operation, 25 °C ambient temperature, mains voltage 230 V/50 Hz, free-operating

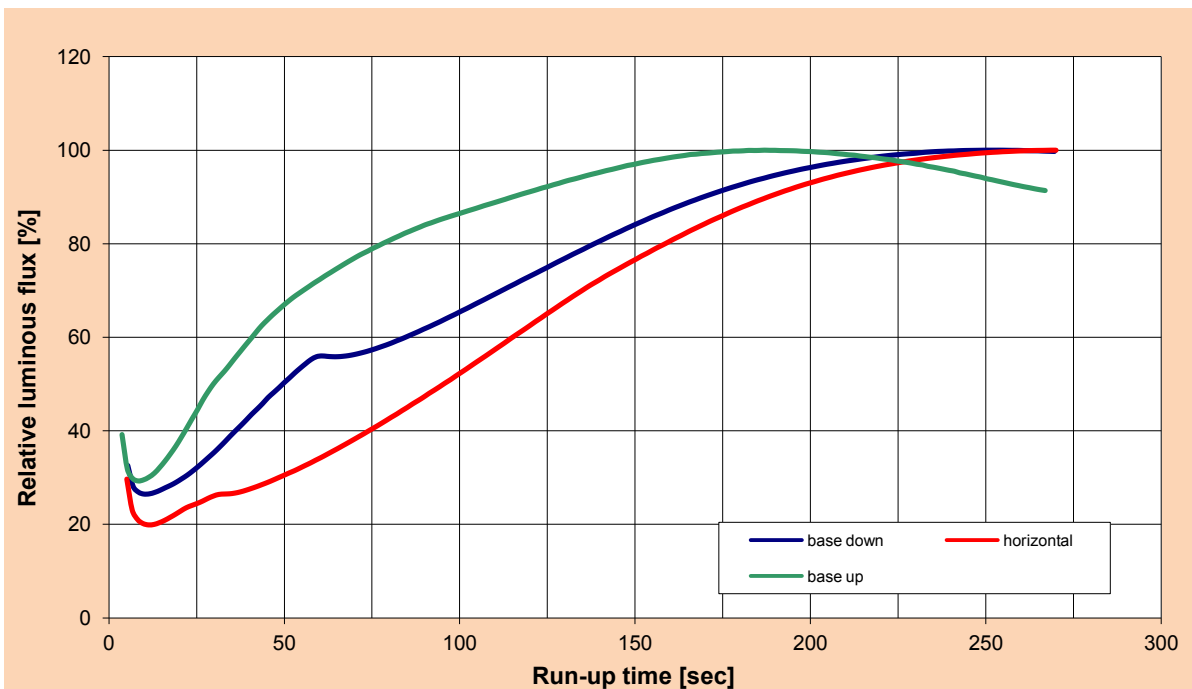

Typical run-up behavior of OSRAM DULUX® lamps (except special models) in ECG operation, 25 °C ambient temperature, mains voltage 230 V/50 Hz, free-operating

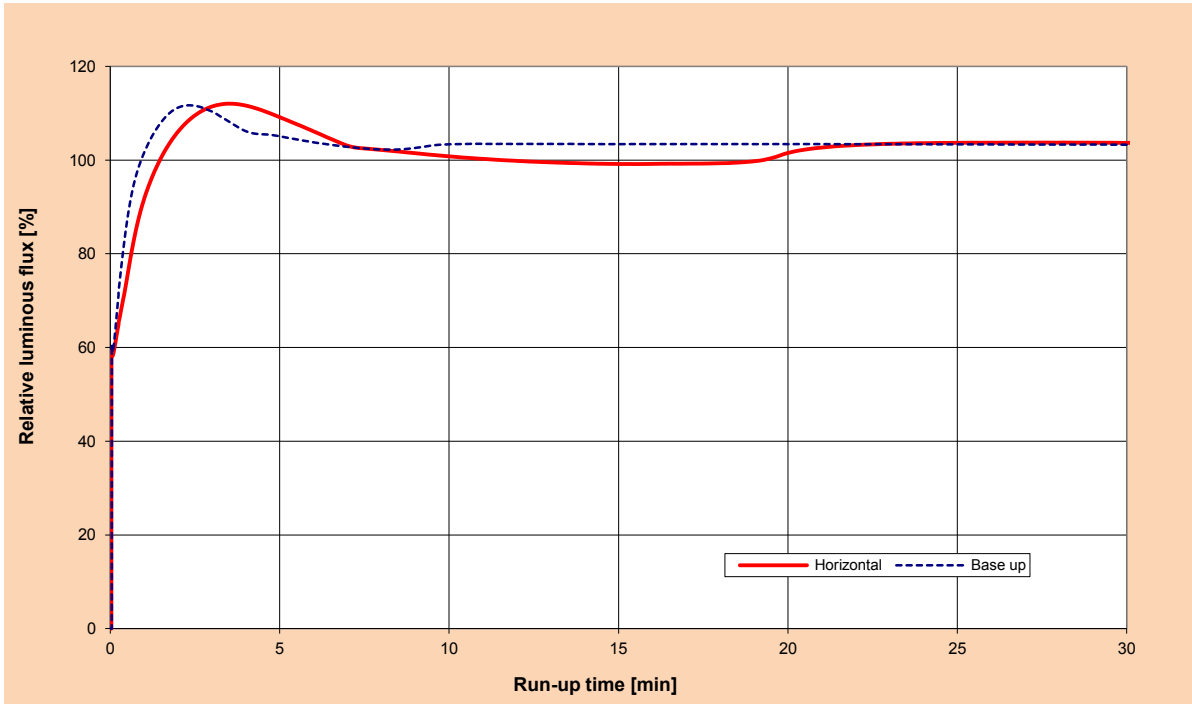

Typical run-up behavior of OSRAM DULUX® L SP lamps in a side surface mounted luminaire until 90 % of the luminous flux is reached.

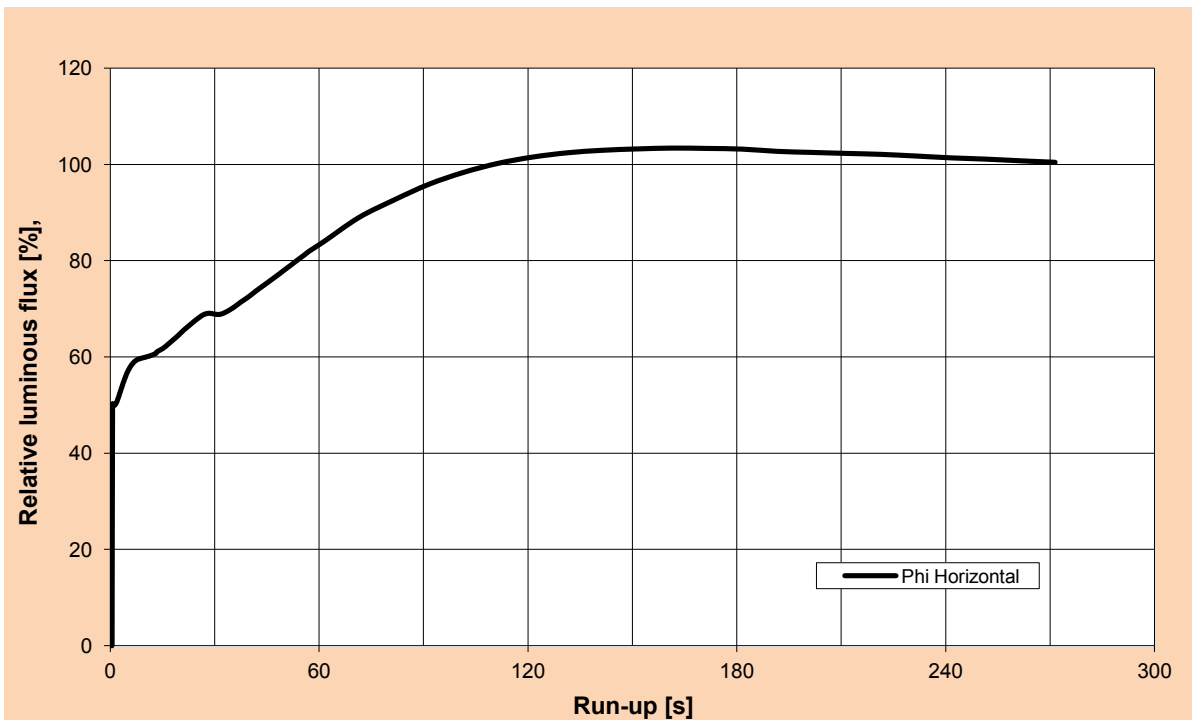

Typical run-up behavior of OSRAM DULUX® T/E HE (high efficiency lamps) in ECG operation (long off time), 25 °C ambient temperature, mains voltage 230 V/ 50 Hz, free-operating horizontal

Run-up behaviour of DULUX® CONSTANT lamps.

The run-up behaviour of DULUX® CONSTANT lamps is different, slower compared to the standard Cold Spot DULUX® lamps. That's because the amalgam in the discharge vessel absorbs almost all of the mercury from the gas in the tube, during the off time period, and needs to heat up properly after ignition, to release again the mercury to the discharge. Therefore DULUX® CONSTANT lamps run-up slower or start even as mercury free, with pink light output for a short time, until the amalgam

heats up and releases mercury into the discharge. This behaviour can be especially observed under lower temperatures.

Therefore in CONSTANT lamps an additional run-up amalgam is positioned in the direct neighbourhood of the electrode. After the lamp is switched on, the electrode will heat up the flag containing the run-up amalgam, so that mercury is directly released into the discharge. This results in a quick run-up behaviour of the CONSTANT lamp that is nearly identical to a Cold Spot lamp.

Once all the mercury from the run-up amalgam is released, the operation amalgam will take over the Hg vapour pressure control, until its final stabilization (until the light output is stabilized).

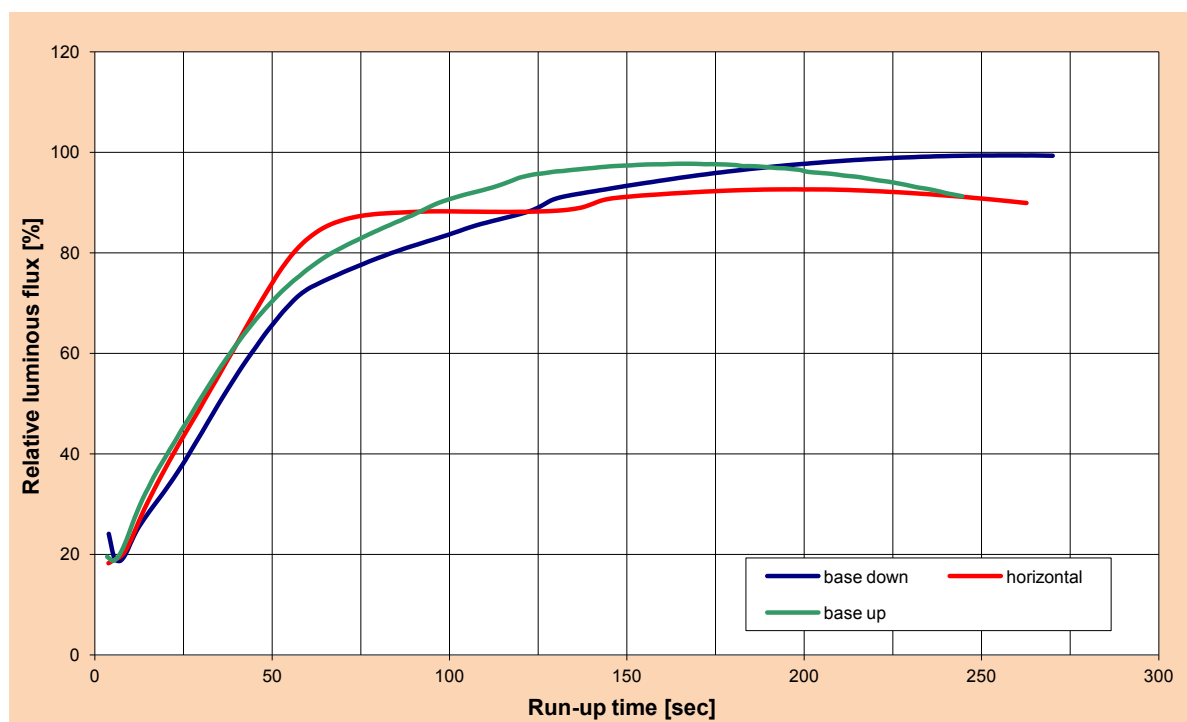

Typical run-up behaviour of OSRAM DULUX® T/E CONSTANT (amalgam lamps) in ECG operation, 25 °C ambient temperature, mains voltage 230 V/ 50 Hz, free-operating

4.4 Operating values of the lamps as a function of mains voltage

- Operating position: Base up, free-operating
- Ambient temperature: 25 °C

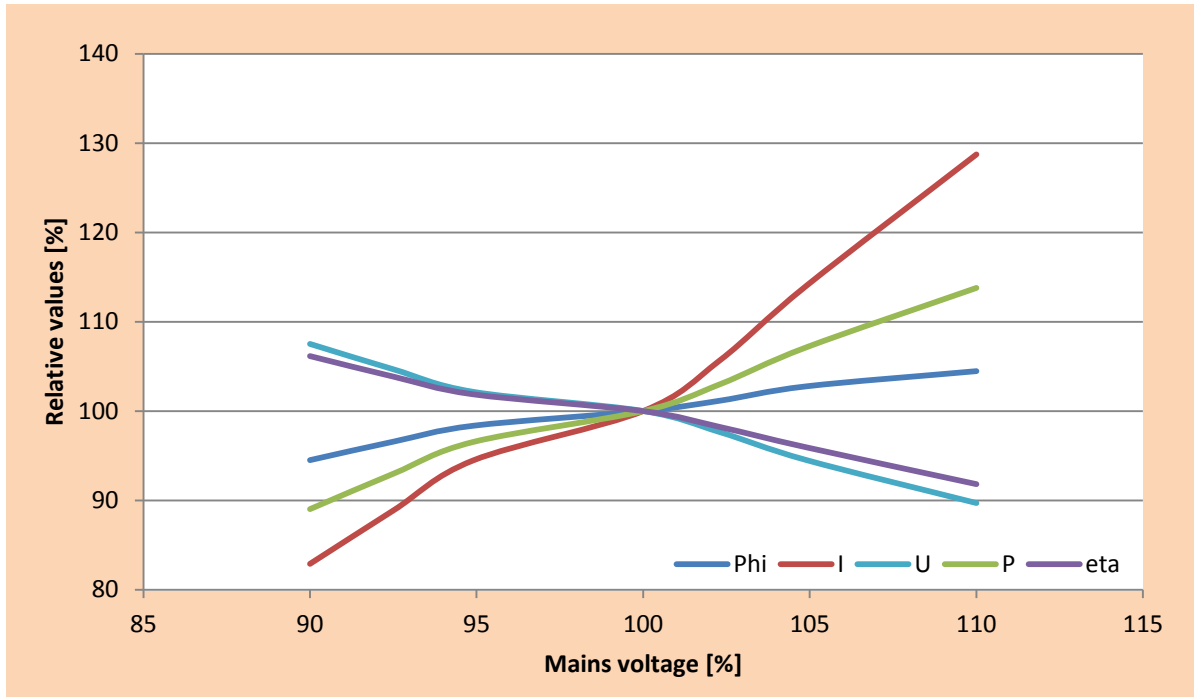

Typical curves for the electrical and photometric data as a function of mains voltage for OSRAM DULUX® lamps in reference magnetic ballast operation.

For ECG operation the variation of luminous and electrical parameters with variation of mains voltage depends strongly on the individual ECG design. There are current controlled, power controlled and mixed controlled characteristics available, which keep the respective electrical parameters more or less constant. The photometric parameters of the lamp will follow the operational parameters of the ECG.

4.5 Operating values of the lamps as a function of ambient temperature

- Operating position: Base up, free-operating
- Mains voltage: 230 V

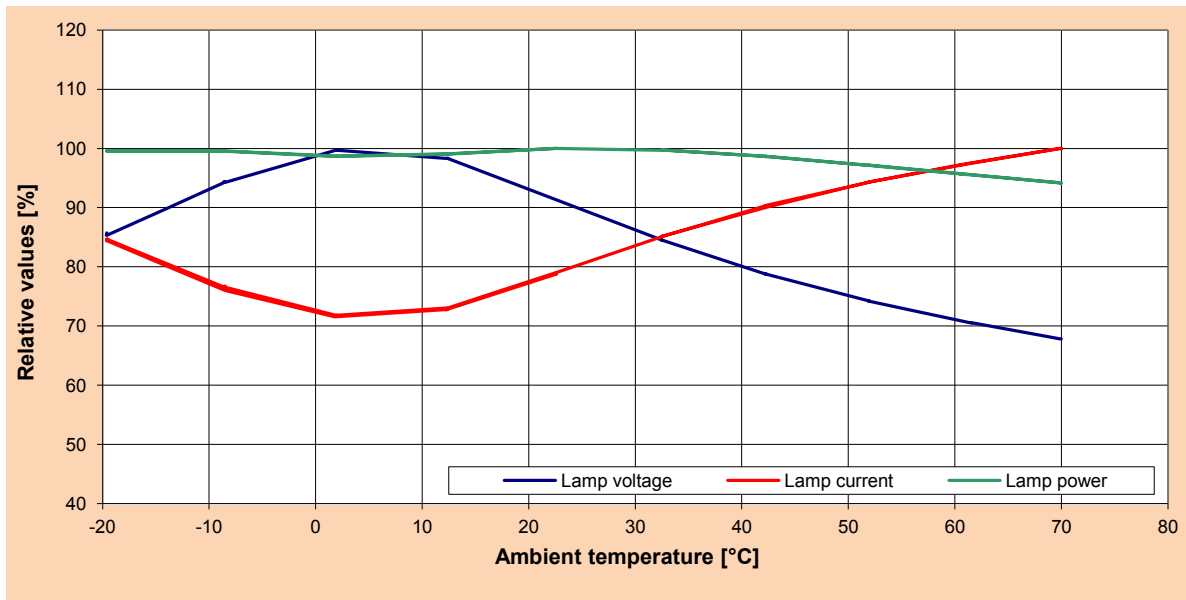

curves for the electrical data as a function of ambient temperature for OSRAM DULUX® lamps in magnetic operation

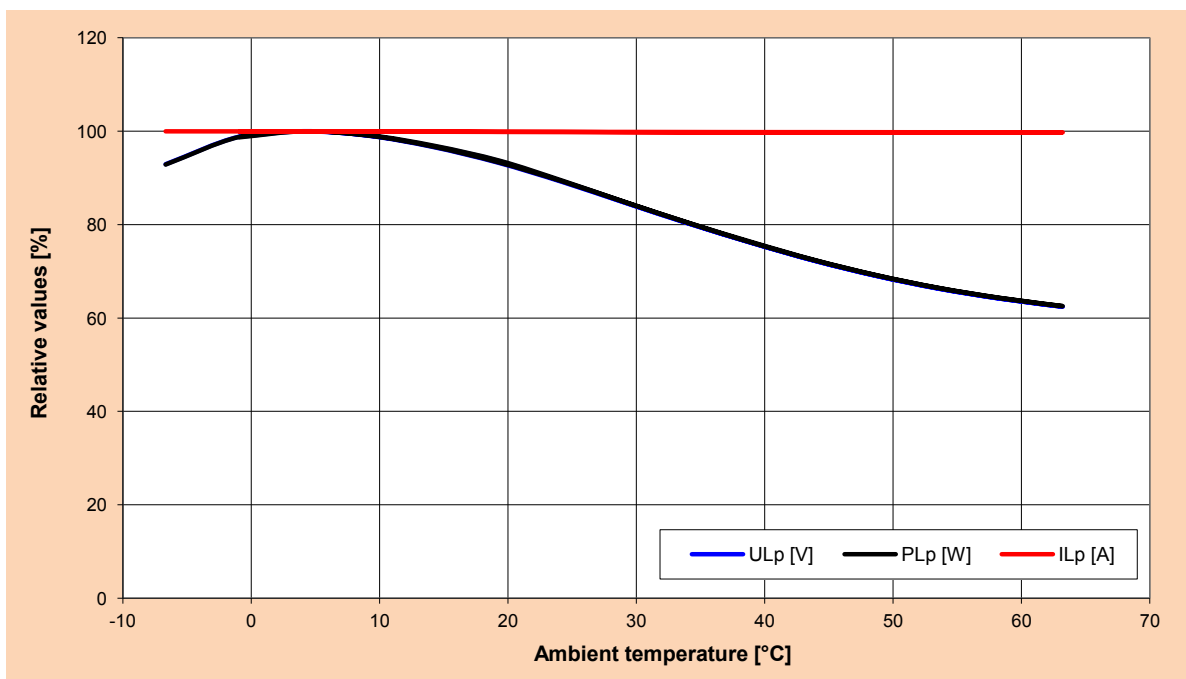

Typical curves for the electrical data as a function of ambient temperature for OSRAM DULUX® lamps in ECG operation with constant current

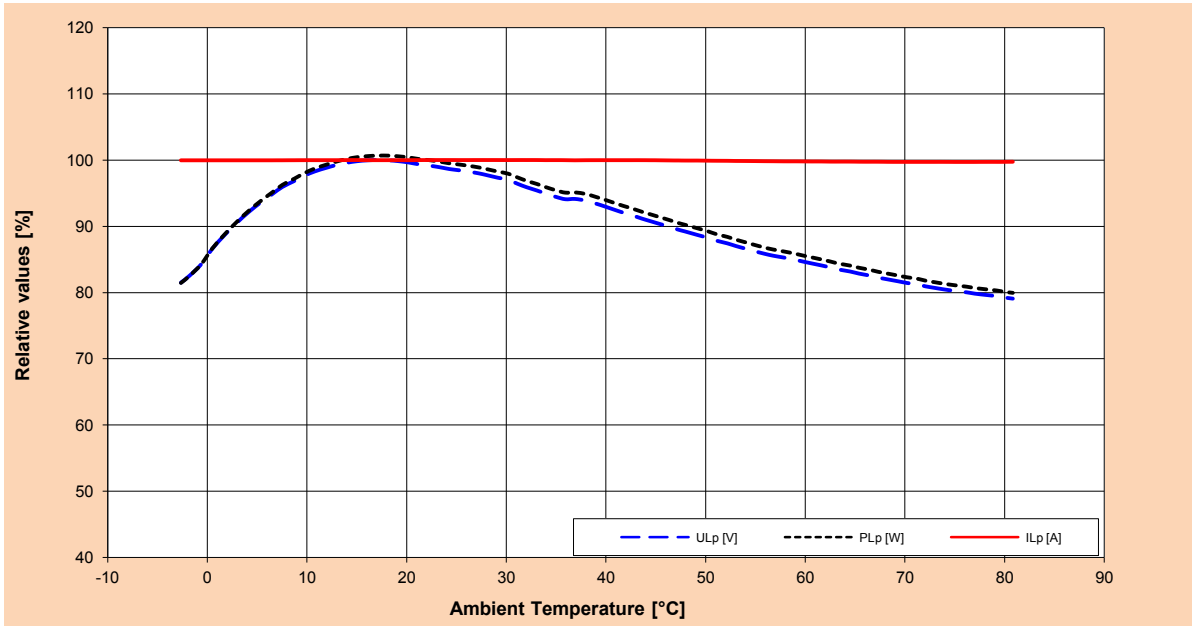

Chart for the electrical data as a function of ambient temperature for OSRAM DULUX® L CONSTANT in constant current operation

4.6 Luminous flux as a function of temperature and operating position

OSRAM DULUX® lamps achieve 100 % luminous flux at ambient temperatures of 15°C or 25°C respectively, depending on the operating position, after a certain run-up time has elapsed, as the graphs above show (see 4.3).

The OSRAM DULUX® HE range achieves 100% luminous flux at an ambient temperature of about 35°C.

For free-operating lamps, the ambient temperature corresponds to the room temperature. If lamps are operated in luminaires, the temperature in the immediate vicinity of the lamp is the one that is relevant to any measurement of luminous flux.

The lamps can be operated in any operating position. However, different burning positions and different ambient temperatures will lead to different luminous flux values. This is due to temperature changes at certain locations on the lamp.

OSRAM DULUX®, OSRAM DULUX® HE, SP, XT and ES lamps which use the standard Cold Spot technology, luminous flux is controlled by the so called Cold Spot. For this reason, we speak of the cold spot temperature. This temperature affects the mercury vapour pressure in the lamp and therefore the luminous flux. The luminous flux/temperature graph depends on the operating position of the lamp. Different operating positions cause the cold spot to be heated in different ways and reach different temperatures. Knowledge of the luminous flux/temperature graph is important for light fitting designers. The base-up operating position is preferred for indoor lighting, for example, whereas the base down operating position for out-door lighting (compare the values at 0 °C, for example).

For OSRAM DULUX® CONSTANT technology based lamps, amalgam controls vapour pressure and luminous flux. Similarly to the cold spot, the amalgam temperature is affected not only by the ambient temperature, but in certain way by the operating position of the lamp. And so the luminous flux/temperature graphs for different operating positions are different.

OSRAM DULUX®, HE, OSRAM DULUX® CONSTANT lamps are optimised for various temperature ranges.

OSRAM DULUX® CONSTANT lamps are ideal for high ambient temperatures. They produce 90 % of their maximum luminous flux over a wide temperature range from 5°C to 70°C. Installed in a suitable light fitting, the lamps are able to achieve high performance even under cold ambient temperatures too.

If OSRAM DULUX® CONSTANT lamps and OSRAM DULUX® Cold Spot lamps are combined in the same installation there will be visible differences in colour perception and brightness. For this reason these two types may not be mixed.

Depending on the operating position the maximum luminous flux will be reached only after a certain Run-up time (see 4.3). Under optimum conditions in magnetic ballast and ECG operation, all the lamps require an aging period of 100 h.

For DULUX D, DE, T, T/E and CONSTANT multilimbed lamps in horizontal operating position it is important to know that the location of the electrodes (facing towards to or facing away from the reflector) has a direct impact on the performance of the lamp. Differences in luminous flux or brightness will appear. Electrodes facing towards to the reflector will result in a maximum luminous flux at higher ambient temperature than for the case with the electrodes facing away from the reflector. On the other hand, with the electrodes facing towards to the reflector the cap temperature will be significantly increased compared to operation with the electrodes facing away from the reflector (see 4.8.1).

Note that it is essential for the design of the luminaire to perform the light and temperature measurement for both kinds of horizontal lamp orientation. Under any conditions the maximum lamp cap temperature may not be exceeded.

4.6.1 Luminous flux/temperature graphs for OSRAM DULUX® lamps in general

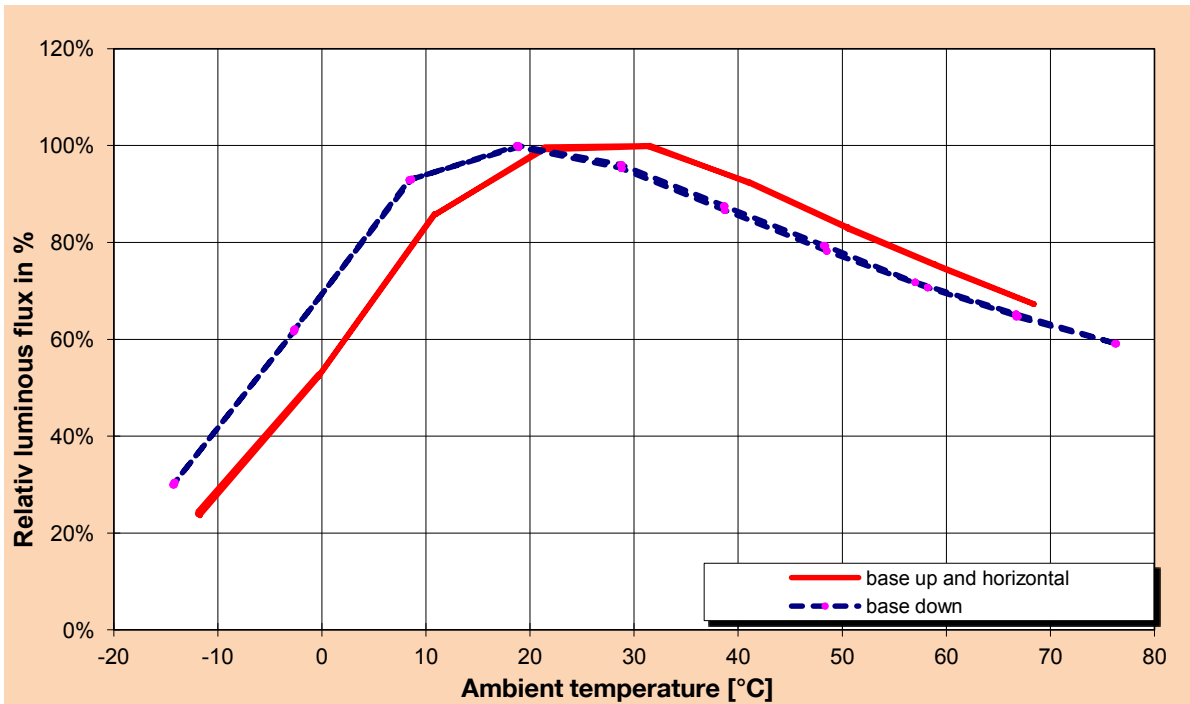

Typical luminous flux/temperature graphs (here OSRAM DULUX® T/E)

4.6.2 Luminous flux/temperature graphs for OSRAM DULUX® HE base up (horizontal)

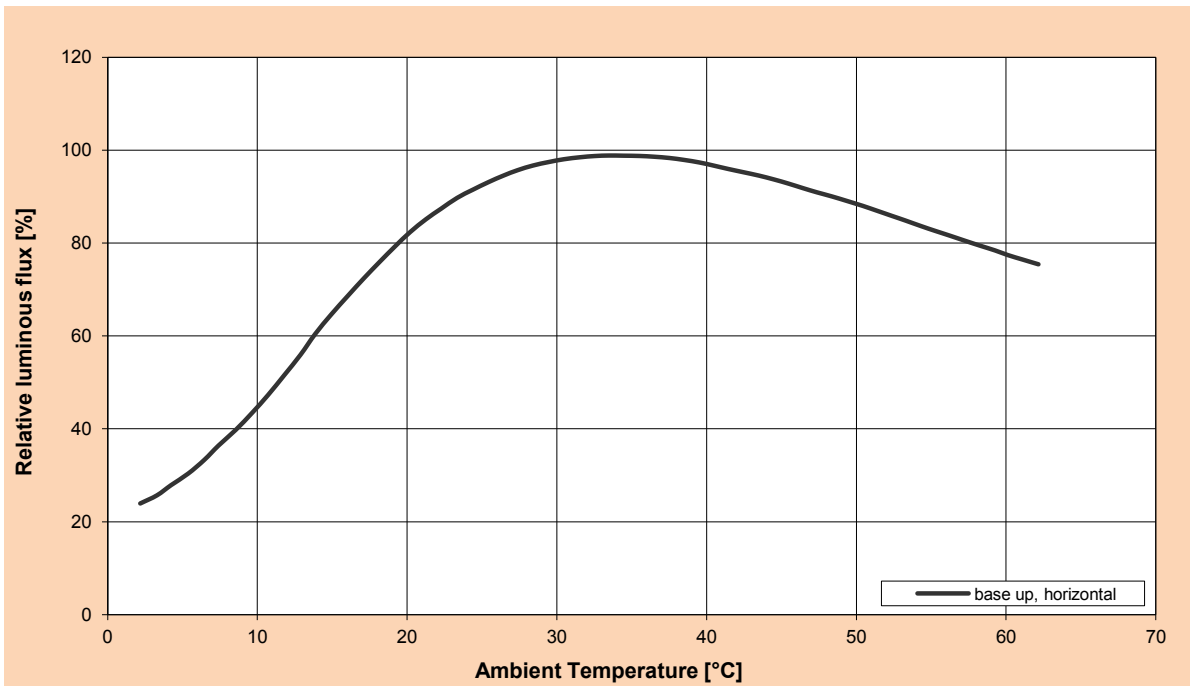

The luminous flux for the DULUX T/E HE lamps peaks at 35°C in order to meet the requirements from application with increased temperature inside luminaires.

4.6.3 Luminous flux/temperature graphs for OSRAM DULUX® CONSTANT lamps

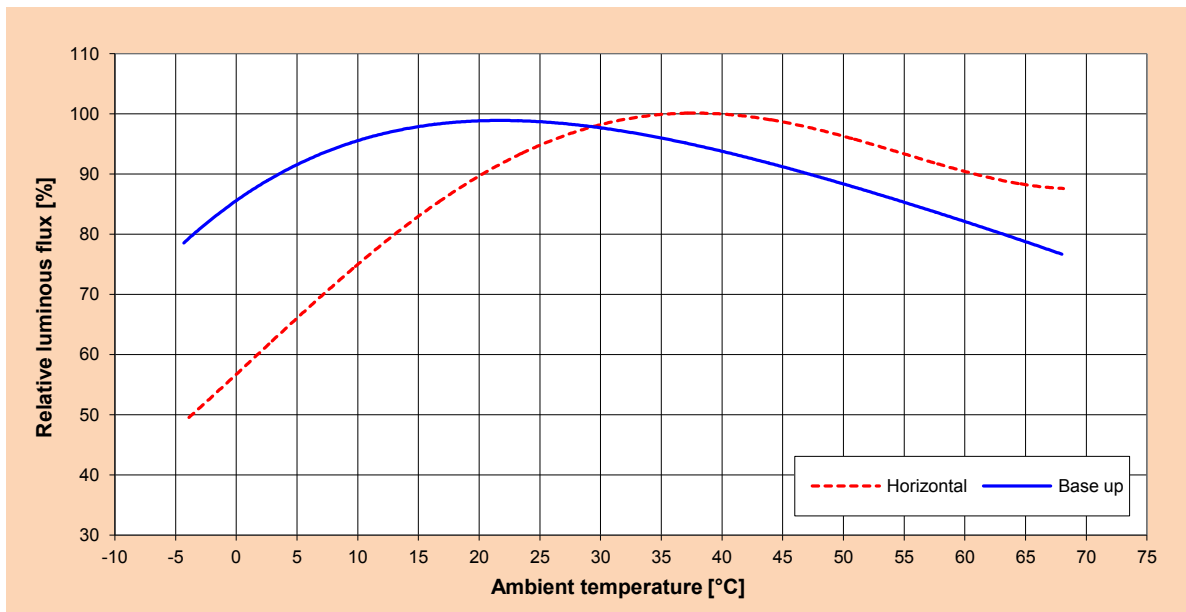

4.6.4 Luminous flux/temperature graphs for OSRAM DULUX® L SP for outdoor lighting

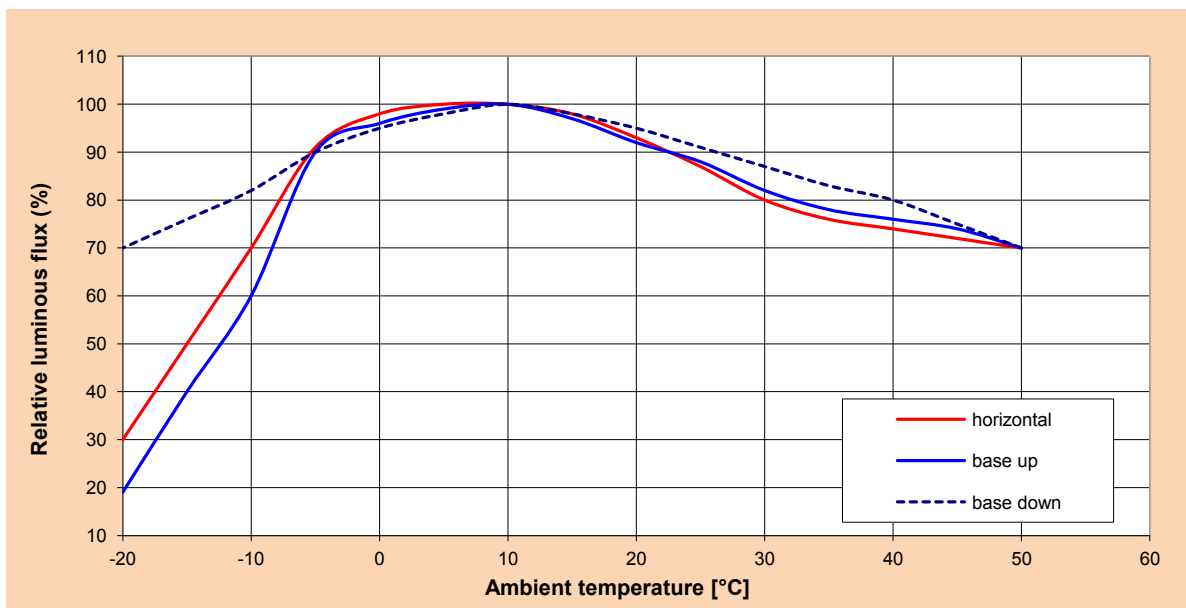

4.6.5 Luminous flux/temperature graphs for OSRAM DULUX® L Constant

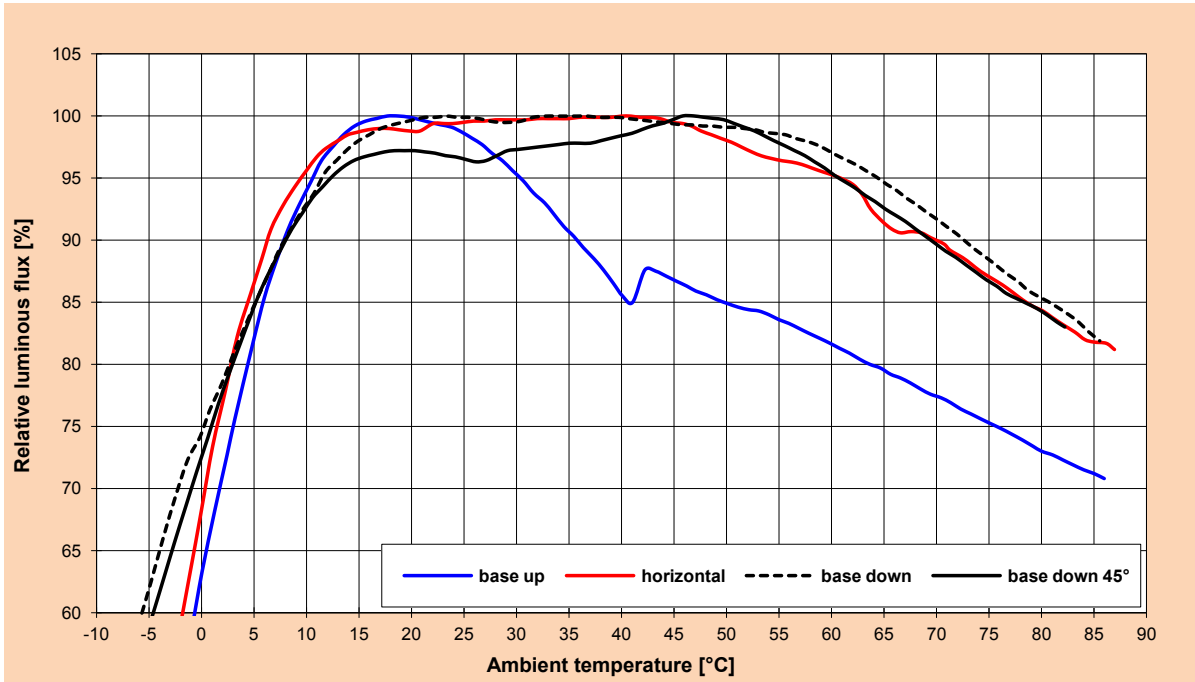

4.6.6 Operation at high temperatures

On conventional linear fluorescent lamps, the cold spot is normally in the centre of the lamp. Additionally the luminaire will generally have a large radiating surface which will ensure moderate tube wall temperatures and high efficiency. In contrast to linear fluorescent lamps, compact fluorescent lamps are much shorter despite having high lamp wattages. Therefore there is a tendency to make luminaires as small as possible. Often the thermal characteristics are ignored.

In particularly small enclosed luminaire systems the temperatures at the points on normal OSRAM DULUX® lamps that have a major influence on luminous flux are so high that luminous flux and therefore the efficiency of the luminaire are reduced appreciably.

Since in such cases the lamps are no longer operated at their optimum, there are also changes in the electrical values of the lamp (reduced lamp power) at high ambient temperatures, which in turn will impair the control gear and shorten the life of the lamp. Therefore it is important to take into account the maximum temperatures permitted on the lamp (see 4.8).

At high ambient temperatures, where OSRAM DULUX® Cold Spot lamps cannot be operated at their optimum (reduced luminous flux), it is advisable to use OSRAM DULUX® CONSTANT lamps to achieve maximum luminous flux. Since they achieve their optimum mercury vapour pressure over a wide range of lamp ambient temperature, CONSTANT lamps operate at their optimum efficiency under the same conditions in narrow luminaires and therefore achieve a higher lamp power.

All the electrical and photometric values (lamp current, lamp voltage and luminous flux) relate to the higher lamp output. In narrow luminaires equipped with OSRAM DULUX® CONSTANT lamps, there is therefore more heat released than it is the case with Cold Spot OSRAM DULUX® lamps. This leads to an increase in temperature at the IEC measuring point of the lamp and the Tc point of the electronic control gear and must be taken into consideration when designing the luminaires, or when replacing a Cold Spot lamp by a CONSTANT lamp in an existing narrow fitting. (see measuring points, chapter 4.8).

For more information related to the maximum permitted temperature at the IEC measuring point, see chapter 4.8.

4.6.7 Operation at low temperatures

The following points must be taken into account when operating OSRAM DULUX® lamps on magnetic ballasts or ECGs at low temperatures:

1. The lamp must be capable of starting at the required temperature.
2. After ignition, the tube wall must warm up sufficiently for the lamp to operate

within its optimum range

The low ambient temperatures at which OSRAM DULUX® will ignite reliably in conjunction with magnetic ballasts are shown in 4.2. If operated with suitable electronic control gear, OSRAM DULUX® lamps with four-pin bases can ignite at even lower temperatures.

In low-temperature applications, the lamps should be used only in enclosed luminaires. It is important for the luminaire to be of such volume, that the lamp(s) can warm up rapidly so that ambient temperatures at which the lamps will operate efficiently are reached within a short time (especially using CONSTANT lamps, which need a longer time to reach the optimal temperature and light output – see 4.3). If there are considerable fluctuations in temperature, the luminous flux/temperature graphs for the different operating positions should be studied in order to achieve a suitable compromise between lamp and luminaire efficiency.

Operation at low ambient temperatures should be taken into consideration when designing the light fitting, especially for CONSTANT lamps. This is to improve the run-up behaviour and to enable the lamps to reach an optimal and stable luminous flux level.

4.7 Dimming

Important notes regarding the dimming of single capped CONSTANT and Cold Spot lamps:

For optimum operation, new lamps should be aged for 100 hours at full output before they are dimmed for the first time.

CONSTANT lamps react more slowly than Cold Spot lamps on variations in supplied electrical power or ambient temperature. For this reason it is strictly recommended not to mix the two types in an installation.

After stabilisation, colour temperature differences can be visible between dimmed (3 % luminous flux) and undimmed lamps (100 % luminous flux).

When the lamps are dimmed to the lowest dimmer setting (3 % luminous flux) the colour temperature shift compared with undimmed lamps might initially be significant. After a stabilization period of 30 to 40 minutes (for CONSTANT lamps) or 20 to 30 minutes (for Cold Spot lamps) this difference is reduced again.

4.7.1 Dimming of OSRAM DULUX CONSTANT lamps

The technical requirements for dimming also apply to CONSTANT lamps without restrictions. Note also that the chemical activity of the amalgam causes a delayed reaction of the lamp with regard to changes in power. This generally occurs with visible differences from one lamp to another. When CONSTANT lamps are dimmed there may therefore be noticeable differences in brightness and colour perception between lamps of the same type, even if they are operated under identical conditions.

The luminous flux of free-operating OSRAM DULUX® CONSTANT lamps stabilises at 100 % after 15 to 30 minutes. In the case of OSRAM DULUX® Cold Spot lamps the luminous flux stabilizes within less than 10 minutes.

These differences in brightness between CONSTANT lamps of the same wattage can also occur if the lamps are operated in luminaires with different volumes. In such cases the different temperatures within the luminaires have an effect on the light output of the lamps.

CONSTANT lamps can however be dimmed, with the restrictions mentioned above. For detailed information about CONSTANT lamps in dimming operation in conjunction with OSRAM ECG (BAT¹) please see www.osram.com.

If the lamps are stored or switched off for a long period of time (> 20 hours) the mercury may migrate into the amalgam. At low dimmer settings and low ambient temperatures, there is then the possibility that the lamp will produce only very low light output (Hg-free stage, burning pink). This is caused by a too low discharge temperature and no mercury present in the discharge (described in 4.3).

The solution is to allow the lamp to operate for about 5 minutes at full output and then to dim it (no damage to the lamp).

For optimum operation, new lamps should be aged for 100 hours at full output before they are dimmed for the first time.

¹ best available technology

Why is a 100 h ageing period necessary?

To meet the electrical and photometric requirements, all compact fluorescent lamps have to be aged (operated) for 100 hours according to IEC 60901 (single capped fluorescent lamps). This is necessary to stabilise lamp operation and get the emitter material on the electrodes into its final shape.

Compact fluorescent lamps operated with dimmable electronic control gear (BAT) must always be stabilised at full (100%) light output. Intermittent operation at full light output is acceptable to reach the 100 hours criteria.

Avoiding operation of the lamps for 100 hours at full light output will result in flickering and premature blackening which finally yields reduced life of the lamps.

1. Recommendation for new installations:

Usually in the construction phase at the building site, all lamps in the light fittings must be operated at full light output and **NOT** in dimmed mode. Under these conditions the electrodes will be stabilised at the time the lighting installation is provided (hand over).

In particular in light ceilings or Light fittings, in which compact fluorescent lamps are not directly visible, stabilising the lamp for 100h is an absolute advice.

2. Recommendation for the replacement of lamps in existing lighting installations:

Compact fluorescent lamps have long life span and are manufactured to tight tolerances. Dimming and non dimmed applications have the same life span (mortality) and same lumen maintenance of the lamps. We recommend bulk replacement and in dimmed application the replaced lamps must have been aged for 100 hours at full light output.

In some installations with BMS (Building Master Control System) control, it may be difficult to age the lamps at 100% light output. In such applications, we recommend that the lamps are aged separately in another location. This can be realised in an operating position, different from the final application.

Some advance BMS control have an automatic detection when lamps are replaced that may allow stabilising of lamps by operating at full light output for 100 hours before dimming is applied.

Conclusion:

It is necessary to stabilise the lamps for 100 hours at full light output. Failure to do this will result in short lamp life.

Scientific approach

As mentioned above, there is the requirement that compact fluorescent lamps shall be operated for a minimum of 100h at rated lumen output, i.e. not dimmed, prior to any dimmed lamp operation. Consumers often ask whether this requirement is really necessary, why it is necessary and what would happen if there is no 100h burn-in period at rated discharge current.

The answer to this question lies in the chemical structure of the emitter material on the electrode coils of the low pressure discharge lamps.

All electrode coils of low pressure discharge lamps from any brand are usually coated with a so called emission mix, which is a mixture of Barium- Strontium- and Calcium-Oxide. This mixture of oxides reduces the electron work function of the electrode. That means, the energy, which is required to drag current out of the electrode into the discharge of the lamp is reduced. The reduction is as high as about a factor of 2 to 3.

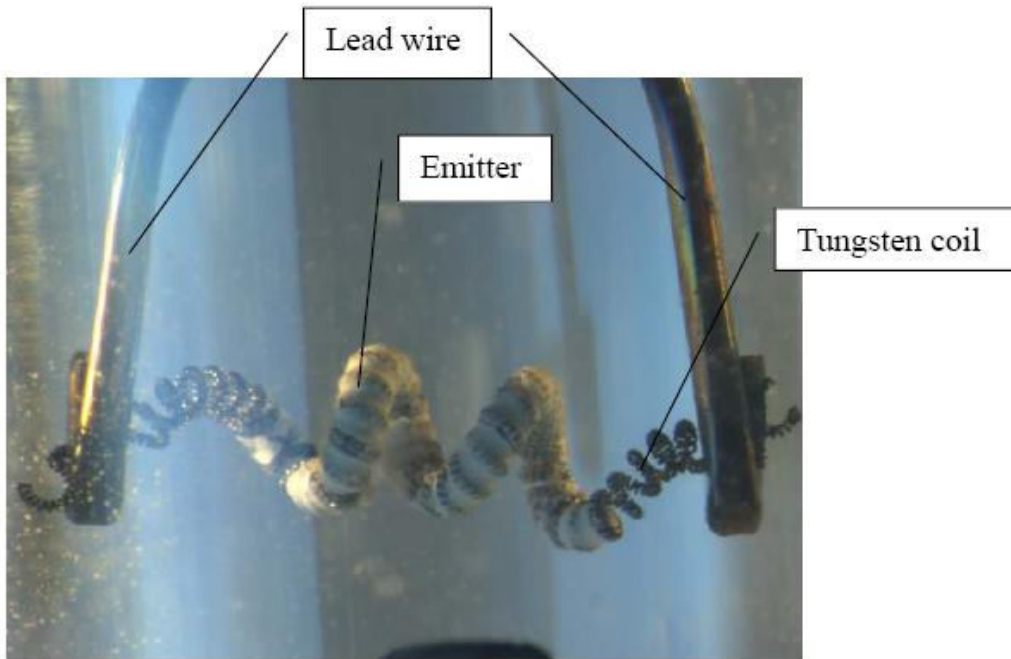

Picture of an electrode for low pressure discharge lamps, consisting of 2 lead wires and a tungsten electrode coil which is covered by (white) emitter.

The problem with these oxides is that they are highly hygroscopic. This means, if they come into contact with air, they will suck up a lot of moisture which then is trapped inside of the lamp, leading to low light output, high lamp voltage and short lamp life. The trick, lamp manufacturers use, is to put Barium-, Strontium- and Calcium-Carbonate on the electrodes instead of the oxides. The carbonates are stable when they are in contact with air. During the exhaust process of the lamp, when the air is pumped out of the lamp and the lamp is then filled with the designed fill gas, the electrodes which are covered with the carbonates are heated up to a temperature of 600°C and above. At that high temperature the carbonate changes into oxide by releasing CO₂ as shown in the equation.

After this reaction is finished, another chemical reaction is necessary to reduce the electron work function of the electrode-emitter system, where atomic Barium is released and transported to the surface of the emitter. The reaction takes place at the surface of the tungsten wire, which the electrode is made of below the emitter coating and follows the equation

Once enough atomic Ba has reached the outer surface of the emitter, the electrode is ready for its work. This last reaction then continues over the whole life of the lamp and electrode.

When the reaction is started for the first time in a new lamp, it will take a significant amount of time until the first coverage of Ba on the emitter surface is ready. This process needs a high emitter and coil temperature, which usually is only given when the lamp operates at the rated discharge current with a hot spot on the electrode where a temperature of about 1900K is reached. If the lamp is operated in a dimmed mode, the temperature on the coil is lower and got a wider distribution. Therefore the described process does not happen as effectively as in the operation at rated current. The consequence then is that the electrode is not in a proper shape and the electron work function is higher than with a properly conditioned electrode. This makes an increased temperature on the electrode necessary which is realized by an increased cathode fall voltage in front of the electrode. By this cathode fall voltage, ions from the plasma are accelerated to the electrode and yield an extra

heating but also sputter material from the electrode, which causes destruction and therefore reduction of electrode and lamp life.

It has to be mentioned that the reaction for the formation of Ba on the emitter surface as shown above needs to take place right at the beginning of lamp operation, i.e. in the first 100h. Once the lamp has been operated some time in a dimmed mode without the 100h burn-in period, the reaction will not happen in a proper way anymore, because the structure of the W – BaO interface on the surface of the electrode under the emitter coating has changed.

4.8 Lamp temperature, safety and limit values

Temperature measuring points are defined for OSRAM DULUX® lamps. The temperatures measured at these points must be within the thresholds for a safe and reliable operation of the lamps.

Temperature measuring points:

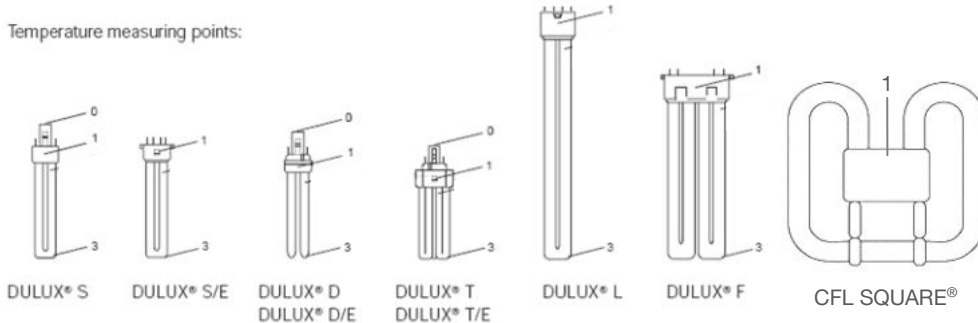

Measuring point	Description	Max. temp.
0	This point is located at the bottom of the base and is determined by the thermal load capacity of the glow starter installed in the bases of two-pin lamps for conventional operation. It is therefore relevant only for these lamps (OSRAM DULUX® S, D, T and T IN).	90°C _n according to EN 60901
1 IEC Measuring point (old - for information)	Information for lamp holder manufacturers Defined as the point lying between the tubes containing electrodes on a line tangential to the tubes. The limit value for this measuring point has been defined in the relevant standard for safety reasons. (If this maximum temperature is exceeded the plastic base may start to soften (applies to end of life).	Refer to chapter 4.8.1 Maximum allowed temperature and measuring conditions according to IEC 61199.
1* IEC measuring point (new)	For luminaire manufacturers Defined as the point lying between the tubes containing electrodes on a line tangential to the tubes. The limit value for this measuring point has been defined in the relevant standard for safety reasons. (If this maximum temperature is exceeded the plastic base may start to soften (applies to end of life).	Refer to chapter 4.8.1 Maximum allowed temperature and measuring conditions according to IEC 61199.
3 Cold spot measuring point	Applies only to OSRAM DULUX® two-pin and OSRAM DULUX® four-pin Valid for Cold spot lamps. Corresponds to the cold spot for base-up measuring burning position and a free-operating lamp. Under certain circumstances, however, the cold spot may shift to somewhere else on the lamp surface than measuring point 3. Exceeding the maximum permitted temperature has a considerable impact on the electrical and photometric data of the lamp and will cause the lamp to fail. For CFL Square lamps the cold spot is located inside the lamp cap. For measuring purposes specially prepared lamps are necessary.	In magnetic and ECG operation max. 100°C (approx. <50% luminous flux) optimum 40°-50°C (=100% luminous flux)
3 Temperature limit for lamp performance of CONSTANT lamps	For safety reasons a new measuring point located on the glass bend of the lamp was defined. Exceeding the maximum permitted temperature on measuring point 3 has a considerable impact on the electrical and photometric data of the lamp and can lead to lamp failures or a reduced lamp life time.	OSRAM DULUX® L CONSTANT 40W, 55W, 80W, maximum 125°C OSRAM DULUX® T/E CONSTANT 26W, 32W, 42W, maximum 150°C
Amalgam measuring point	CONSTANT lamps : The measuring point for CONSTANT lamps is located on the glass tip of the amalgam reservoir inside the lamp base. This temperature can be measured only with specially prepared lamps.	DULUX T, T/E CONSTANT, optimum amalgam temperature 100°C – 160°C (= 90% luminous flux) Measuring point for DULUX® L CONSTANT is not accessible.

1) Measuring Conditions:
 25°C ambient temperature, draught free air
 Reference ballast
 Supply voltage $U=1.06 \times U_{...}$

4.8.1 Maximum temperatures for OSRAM DULUX® lamps

The following table shows the permitted maximum temperatures on OSRAM DULUX® lamps. Exceeding one or more of the maximum values specified here will lead to:

- a noticeable reduction in lamp life
- and/or damage to the CCG or ECG
- and/or damage to the lamp base and the luminaire holder.

In the case of OSRAM DULUX® S, D, T (without amalgam), L and F the limit value of 100 °C at **measuring point 3** (cold spot) should not be exceeded. Exceeding this limit value may cause the lamp to fail. At cold spot temperatures above the optimum (see table 4.8) there are changes in the electrical and photometric data of the lamps (the luminous flux is no longer at 100 %).

In case of CFL SQUARE® lamps, the cold spot is located inside the cap, i.e. special prepared lamps are needed.

In case of CONSTANT lamps (with amalgam) mercury vapour pressure inside the lamp is controlled by the amalgam temperature, which needs to be measured inside the lamp cap (special prepared lamps are needed).

The limit value at measuring point 1 is 140°C for OSRAM DULUX® lamps with and without amalgam. This maximum value was defined as part of the IEC standard for safety reasons. Exceeding this value leads to softening of the plastic base and discolouration of the base material.

Measuring point limit values	0	3
	As per EN 60901	
OSRAM DULUX® 2-pin (CCG operation)	90°C	100°C
OSRAM DULUX® 4-pin (ECG operation)	-	100°C
OSRAM DULUX® CONSTANT 2-pin (CCG operation)	90°C	-
OSRAM DULUX® CONSTANT 4-pin (ECG operation)	-	-
OSRAM CFL SQUARE® (CCG operation)	-	100°C
OSRAM CFL SQUARE® (ECG operation)	-	100°C

For the limit values at **measuring point 1, 1*** for OSRAM DULUX® lamps with and without amalgam please refer to the measuring descriptions and tables below.

Measurement point 1 maximal lamp cap temperatures – locations and values as per IEC 61199

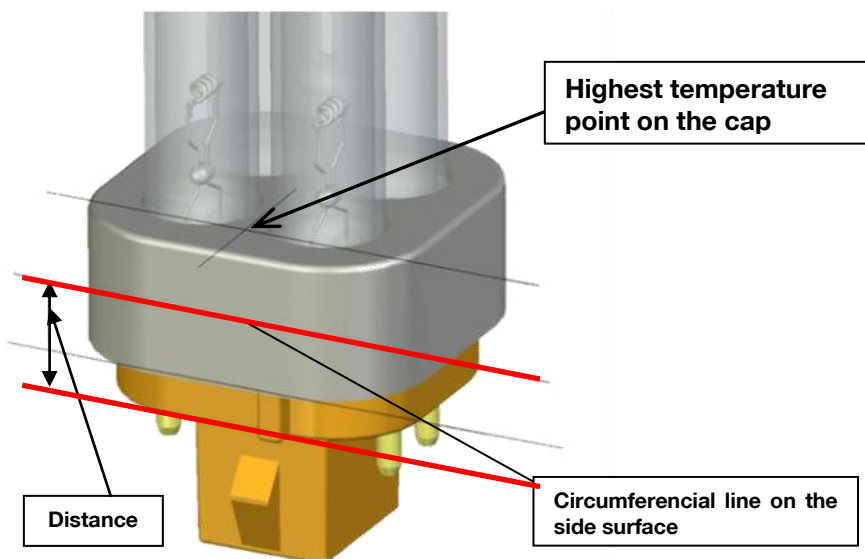

Measurement point 1, locations on the cap surface

A. Information for luminaires manufacturers.

Maximum lamp cap temperature (measuring point 1*).

The highest temperatures on the lamp cap occur close to the electrode-containing legs. Those legs have only one connection (bridge or bend) to another leg.

For lamps having electrodes in adjacent legs (example A)

The temperature shall be measured at the lamp cap surface, on the outer tangent plane connecting the electrode-containing legs, at the point halfway between the two legs. In case there are 2 symmetric outer tangent planes, any of them can be used. If the shortest distance between its position and the surface of the electrode-containing leg is more than 3 mm, the measurement position shall be taken at a position on the tangent at a distance 3 mm from the surface of the electrode-containing leg. In the latter case one shall take measurements at both electrode-containing legs and take the highest temperature reading, to identify the worst case situation in case of asymmetrical thermal load to the electrodes.

For the CFL SQUARE® lamp (GR8 and GR10q caps all wattages)

The temperature shall be measured at a point on the cap surface which is equidistant between the two glass limbs emerging from the cap. It shall also lie on the straight line that joins the axes of the glass limbs.

Example A Dual

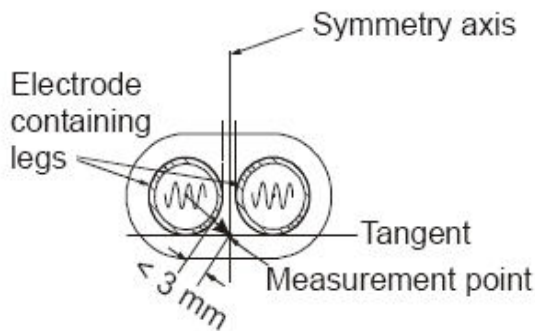

In this example, the measurement point is halfway between the adjacent legs.

Maximum cap temperature, lamps with internal or external starter (test at abnormal operating conditions)

Lamp	Lamp nominal wattage W°	Maximum cap temperature °C
DULUX® F	All	200
CFL SQUARE® 2, 4 pin	All	110 *
DULUX® L (XT, CONSTANT)	18, 24, 36	200
DULUX® S	All	200
DULUX® D, D/E (XT), D ES	All	200
DULUX® T, T/E (CONSTANT)	13, 18, 24	200

* Under consideration.

If a magnetic ballast with (short-circuited) internal or external starter is used, the luminaire designer should ensure that the cap temperature of the lamp, under abnormal operating conditions, does not exceed the maximum cap temperature value shown in the table above.

Luminaires should be tested using the intended lamp with the starter short-circuited (test at abnormal operating conditions), i.e. the cathodes operated in series.

Maximum cap temperature, lamps for ECG operation (test at normal operating conditions)

Lamp	Lamp nominal wattage [W]	Maximum cap temperature [°C]
DULUX® S/E, DULUX® F, DULUX® L (CONSTANT, HE, SP, XT)	All	180
CFL SQUARE® 4 pin	All	100*
DULUX® D/E, T/E (CONSTANT, HE, XT)	All	180

* Under consideration

If a high frequency ballast is used, the luminaire designer should ensure that the cap temperature of the lamp under normal operating conditions does not exceed the maximum temperature value shown in the table above.

B. Information for lamp holder manufacturers

Maximum lamp cap temperature related to the lamp - lampholder interface. (Measuring point 1-old)

The point where the temperature limit is given is the hottest point on the cap surface at a distance x from the reference plane of the cap, as indicated in table below, in the direction of the glass limbs (see: Measurement point 1 location on the cap surface, in chapter 4.8.1 Maximum temperatures for OSRAM DULUX® lamps, p.72).

Temperature point location:

Lamp	Distance X mm
DULUX® S, S/E	8
DULUX® D, D/E, T, T/E, L, F	12

Temperature point for CFL SQUARE® lamps

The point where the temperature limit is given is a point on the cap surface, which is equidistant between the two glass limbs emerging from the cap, and which lies on the straight line that joins the axes of the glass limbs.

Maximum temperatures related to lampholder design

Lamp	Lamp nominal wattage W	Maximum cap temperature °C
DULUX® S/E, DULUX® F, DULUX® L	All	140
CFL SQUARE® 2,4 pin	All	110
DULUX® D, D/E, T, T/E	All	140

4.8.2 Maximum electrical safety values for OSRAM DULUX® lamps as per IEC 61199

Electrical safety data for electronic operation to be observed (normal operation).

SoS max – maximal Sum Of Squares of the pin currents, defines the maximal permanent heating energy supplied to one electrode.

Id max – maximal permitted lamp current. Exceeding the maximal lamp current can lead to damage to lamp, lamp cap or lamp holder.

For lamps in high frequency operation, the pre-heat current must not be applied over a period of more than 10 sec. If a lamp does not start within this period, the current through the electrodes has to be reduced until the SoS value for the currents through the lead wires at each electrode stays below the "Maximum SoS value" as specified in table below. Also at end of lamp life the ballast has to prevent overheating by suitable measures.

Safety data for electronic operation for DULUX® lamp.

Lamp	Discharge current safety limit mA	SoS safety limit A ²
OSRAM DULUX® S/E 7 W	190	0.20
OSRAM DULUX® S/E 9 W	190	0.20
OSRAM DULUX® S/E 11 W	190	0.20
OSRAM DULUX® D/E 10 W	210	0.15
OSRAM DULUX® D/E 13 W	210	0.15
OSRAM DULUX® D/E 18 W	240	0.20
OSRAM DULUX® D/E 26 W	360	0.27
OSRAM DULUX® T/E 13 W	210	0.15
OSRAM DULUX® T/E 18 W	240	0.20
OSRAM DULUX® T/E 26 W ₁₎	360	0.27
OSRAM DULUX® T/E 32 W ₁₎	360	0.27
OSRAM DULUX® T/E 42 W ₁₎	360	0.27
OSRAM DULUX® T/E 11W HE	210	0,06
OSRAM DULUX® T/E 14W HE	210	0,06
OSRAM DULUX® T/E 17W HE	210	0,06
OSRAM DULUX® L 18 W (SP)	690	0.90
OSRAM DULUX® L 24 W (SP)	690	0.90
OSRAM DULUX® L 36 W (SP)	690	0.90
OSRAM DULUX® L 40 W ₁₎	690	0.90
OSRAM DULUX® L 55 W ₁₎	690	0.90
OSRAM DULUX® L 80 W ₁₎	690	0.90
OSRAM DULUX® L 28W HE	250	0,30
OSRAM DULUX® F 18 W	690	0.90
OSRAM DULUX® F 24 W	690	0.90
OSRAM DULUX® F 36 W	690	0.90
CFL SQUARE® 16W	690	0.90
CFL SQUARE® 28W	690	0.90
CFL SQUARE® 38W	690	0.90

1) also for DULUX: CONSTANT

5 Data for control gear manufacturers

Compact fluorescent lamps cannot be operated directly from the mains supply; they need a control gear. This may be integrated in the lamp (as in the case of OSRAM DULUX® EL lamps) or may take the form of an external unit connected between the lamp and the mains outlet (as with all CFLs with pin bases).

Models with two-pin bases are designed to operate with magnetic control gear; lamps with four-pin bases are designed to operate with electronic control gear (high frequency operation). In either case, the operating data of the control gear must be tailored to the lamp data.

5.1 Electronic operation

The advantages of high-frequency operation (BAT) are higher efficiency, longer lamp life, higher number of switching cycles and more comfortable light than it is the case with choke/starter circuits. To make best use of these advantages, however, it is important to ensure that the permissible operating data listed below for preheating, igniting and operating the lamps is followed. The values in the table apply to an operating frequency of 25 kHz and a sinusoidal voltage during operation without starting aid.

5.1.1 Preheating (ECG operation)

Starting lamps with filament preheating (warm start) is recommended by OSRAM as the standard starting procedure. In a warm start, the electrodes are heated by a preheating current with energy $Q_{preheat}$ to the emission temperature before the lamp is ignited.

The necessary or permissible preheating current is determined by the design of the electrodes and the preheating time $t_{preheat}$ selected. Preheating times of less than 0.4 s are generally not permissible for compact fluorescent lamps. This is because with such short times it is impossible to ensure sufficiently uniform heating along the entire length of the electrode. The minimum and maximum permitted preheating energy can be calculated using the parameters in the following table for various preheating times. Violating these limit values will cause blackening around the electrodes and shorter lamp life, particular if the lamp is switched on and off frequently. Compliance with the prescribed limits is tested on control gear using an equivalent resistor R_{sub} which is connected to the control gear instead of the lamp electrodes. The energy fed into this resistor is measured over the selected preheating time. For the testing of the minimum limit $Q_{preheat, min}$ a substitution resistor $R_{sub, min}$ is used. For the maximum limit (correspond with a higher electrode resistance) a substitution resistor $R_{sub, max}$ is used.

The minimum and maximum value of the preheat energy is calculated by

$$Q_{preheat, min} = Q + P t_{preheat}$$

$$Q_{preheat, max} = 2 \times Q_{preheat, min}$$

If electrode preheating is carried out with a constant current $I_{preheat}$ or constant voltage $U_{preheat}$ the necessary current or voltage can be calculated as follows:

$$U_{preheat, constant} = \sqrt{\frac{QR_{sub}}{t_{preheat}} + PR_{sub}}$$

$$I_{preheat, constant} = \sqrt{\frac{Q}{R_{sub}t_{preheat}} + \frac{P}{R_{sub}}}$$

Lamp	P [W]		Q [J]		Rsub [Ω]	
	min	max	min	max	min	max
OSRAM DULUX® S/E 7 W	0.5	1.0	1.0	2.0	30	40
OSRAM DULUX® S/E 9 W	0.5	1.0	1.0	2.0	30	40
OSRAM DULUX® S/E 11 W	0.5	1.0	1.0	2.0	30	40
OSRAM DULUX® D/E 10 W	0.6	1.2	1.0	2.0	30	40
OSRAM DULUX® D/E 13 W	0.7	1.4	1.0	2.0	30	40
OSRAM DULUX® D/E 18 W ₃₎	0.7	1.4	0.9	1.8	18	24
OSRAM DULUX® D/E 26 W ₃₎	0.8	1.6	1.0	2.0	9	12
OSRAM DULUX® T/E 13 W	0.7	1.4	1.0	2.0	30	40
OSRAM DULUX® T/E 18 W	0.7	1.4	0.9	1.8	18	24
OSRAM DULUX® T/E 26 W ₁₎	0.8	1.6	1.0	2.0	9	12
OSRAM DULUX® T/E 32 W _{1) 3)}	0.8	1.6	1.0	2.0	9	12
OSRAM DULUX® T/E 42 W _{1) 3)}	0.8	1.6	1.0	2.0	9	12
OSRAM DULUX® T/E 11W HE	0.7	1.4	1.0	2.0	30	40
OSRAM DULUX® T/E 14W HE	0.7	1.4	1.0	2.0	30	40
OSRAM DULUX® T/E 17W HE	0.7	1.4	1.0	2.0	30	40
OSRAM DULUX® L 18 W ₃₎	0.9	1.8	1.5	3.0	8	11
OSRAM DULUX® L 24 W ₃₎	0.9	1.8	1.5	3.0	8	11
OSRAM DULUX® L 36 W ₃₎	1.0	2.0	1.6	3.2	7	9
OSRAM DULUX® L 40 W ₁₎	0.9	1.8	1.5	3.0	8	11
OSRAM DULUX® L 55 W _{1) 3)}	1.1	2.2	2.4	4.8	5	6.5
OSRAM DULUX® L 80 W ₁₎	1.5	3.0	2.4	4.8	5	6.5
OSRAM DULUX® L 16 W HE	0.75	1.5	0.9	1.8	30	45
OSRAM DULUX® L 22 W HE	0.75	1.5	0.9	1.8	30	45
OSRAM DULUX® L 26 W HE	0.75	1.5	0.9	1.8	30	45
OSRAM DULUX® L 28 W HE	0.75	1.5	0.9	1.8	30	45
OSRAM DULUX® F 18 W	0.9	1.8	1.5	3.0	8	11
OSRAM DULUX® F 24 W	0.9	1.8	1.5	3.0	8	11
OSRAM DULUX® F 36 W	1.0	2.0	1.6	3.2	7	9
CFL SQUARE® 16W ₂₎	0.6	1.2	0.9	1.8	40	50
CFL SQUARE® 28W ₂₎	0.9	1.8	1.1	2.2	12	16
CFL SQUARE® 38W ₂₎	1.0	2.0	2.0	4.0	5.6	8.2

1) Also for DULUX- CONSTANT

2) CFL SQUARE- four-pin base

3) also for XT versions

5.1.2 Starting (ECG operation)

The lamp should not ignite during the preheating time; the open-circuit voltage of the ECG must therefore not exceed a lamp-specific maximum value. After the preheating phase the lamp should ignite reliably; the open-circuit voltage of the ECG must therefore not fall below a lamp-specific minimum value. The following table contains the permissible or necessary limit values for the open-circuit voltage of the ECG. Because of the temperature response of the ignition voltage of fluorescent lamps and compact fluorescent lamps, these values are given for two ambient temperature ranges.

Lamp	Maximum open-circuit voltage during preheating	Minimum open-circuit voltage for ignition	Minimum open-circuit voltage for ignition
	Vrms	Ambient temperature >+10°C Vrms	Ambient temperature -15°C to +10°C Vrms
OSRAM DULUX® S/E 7 W	130	270	320
OSRAM DULUX® S/E 9 W	150	290	340
OSRAM DULUX® S/E 11 W	170	330	370
OSRAM DULUX® D/E 10 W	180	340	360
OSRAM DULUX® D/E 13 W	190	380	420
OSRAM DULUX® D/E 18 W (XT)	220	400	460
OSRAM DULUX® D/E 26 W (XT)	240	420	520
OSRAM DULUX® T/E 13 W	190	400	430
OSRAM DULUX® T/E 18 W	250	430	450
OSRAM DULUX® T/E 26 W	265	500	520
OSRAM DULUX® T/E 32 W (XT)	265	530	550
OSRAM DULUX® T/E 42 W (XT)	265	550	575
OSRAM DULUX® T/E 11 W HE	265	450	575
OSRAM DULUX® T/E 14 W HE	300	475	625
OSRAM DULUX® T/E 17 W HE	350	600	650
OSRAM DULUX® T/E 18 W CONSTANT	250	550	550
OSRAM DULUX® T/E 26 W CONSTANT	265	550	560
OSRAM DULUX® T/E 32 W CONSTANT	265	560	600
OSRAM DULUX® T/E 42 W CONSTANT	265	600	600
OSRAM DULUX® L 18 W (XT, SP)	150	300	320
OSRAM DULUX® L 24 W (XT, SP)	170	320	340
OSRAM DULUX® L 36 W (XT, SP)	190	340	380
OSRAM DULUX® L 40 W ¹⁾	220	360	420
OSRAM DULUX® L 55 W ¹⁾ (XT)	220	360	420
OSRAM DULUX® L 80 W ¹⁾	230	370	420
OSRAM DULUX® L 16 W HE	170	320	375
OSRAM DULUX® L 22 W HE	190	340	410
OSRAM DULUX® L 26 W HE	220	360	450
OSRAM DULUX® L 28 W HE	230	370	420
OSRAM DULUX® F 18 W	130	350	390
OSRAM DULUX® F 24 W	170	400	440
OSRAM DULUX® F 36 W	190	420	480
CFL SQUARE® 16W	265	550	600
CFL SQUARE® 28W	265	550	650
CFL SQUARE® 38W	265	550	560

1) Also for DULUX L CONSTANT

5.1.3 Operating data for undimmed lamps

All the lamp data is specified only for operation at rated current. The lamp current may vary within the tolerance range without affecting lamp life. Detailed data are shown in the table below. In this range there is no need for constant heating current to maintain the electrodes at emission temperature. The critical load of a lamp is determined by two criteria: (1) the maximum lamp current and (2) the maximum current maximum in any lead. The lamp current is the current that goes through the discharge in the lamp. The current maximum in any lead is a limit value for the load capacity of the power supply leads if a heating current flows in addition to the lamp current. The current in any lead equals approximately the lamp current plus the heating current.

Lamp	Minimum lamp current (undimmed) mA	Maximum lamp current _{t₁} mA	Maximum current in any lead mA
OSRAM DULUX® S/E 7 W	120	190	240*
OSRAM DULUX® S/E 9 W	120	190	240*
OSRAM DULUX® S/E 11 W	120	190	240*
OSRAM DULUX® D/E 10 W	135	210	240*
OSRAM DULUX® D/E 13 W	120	190	240*
OSRAM DULUX® D/E 18 W (XT)	160	240	330*
OSRAM DULUX® D/E 26 W (XT)	220	360	480
OSRAM DULUX® T/E 13 W	120	190	240*
OSRAM DULUX® T/E 18 W ₂₎	160	240	330*
OSRAM DULUX® T/E 26 W ₂₎	220	360	480
OSRAM DULUX® T/E 32 W ₂₎ (XT)	220	360	480
OSRAM DULUX® T/E 42 W ₂₎ (XT)	220	360	480
OSRAM DULUX® T/E 11W HE	100	170	170
OSRAM DULUX® T/E 14W HE	100	170	170
OSRAM DULUX® T/E 17W HE	100	170	170
OSRAM DULUX® L 18 W (XT, SP)	260	425	640
OSRAM DULUX® L 24 W (XT, SP)	260	425	640
OSRAM DULUX® L 36 W (XT, SP)	300	500	700
OSRAM DULUX® L 40 W ₂₎	260	425	640
OSRAM DULUX® L 55 W ₂₎ (XT)	450	650	780
OSRAM DULUX® L 80 W ₂₎	425	690	740
OSRAM DULUX® L 16 W HE	130	205	220
OSRAM DULUX® L 22 W HE	130	205	220
OSRAM DULUX® L 26 W HE	130	205	220
OSRAM DULUX® L 28 W HE	130	205	220
OSRAM DULUX® F 18 W	260	425	640
OSRAM DULUX® F 24 W	260	425	640
OSRAM DULUX® F 36 W	300	500	700
CFL SQUARE® 16W	110	195	220
CFL SQUARE® 28W	215	350	380
CFL SQUARE® 38W	340	550	590

This table complies with the latest edition of IEC 60901 and 61199.

*IEC 61199 is currently being revised. As a result, these values may change.

1) Exceeding the maximum lamp current may shorten lamp life (overheating of the base) and a decrease in maintenance

2) Also for DULUX CONSTANT

5.1.4 Dimming

Reducing the lamp current below the minimum value specified in 5.1.3 can be used to reduce the luminous flux of the lamp appreciably below its rated value, thereby dimming the lamp. The dimming range is defined as the lamp current region between the “minimum lamp current (undimmed)” and the “minimum lamp current” in the table below. Please note the following:

- The lamp electrodes must be maintained at emission temperature by a continuous heating current.
- The lamp voltage at lower discharge current is generally higher than the rated value.
- The chromaticity coordinate of the light colour may deviate from its rated value.

In the interest of maximising lamp life, the auxiliary heating current must be matched to the lamp current. If the auxiliary heating current is too low, the lamp electrodes will very quickly be destroyed by sputtering. A constant heating current that is too high will result in excessive emitter evaporation which leads to end blackening.

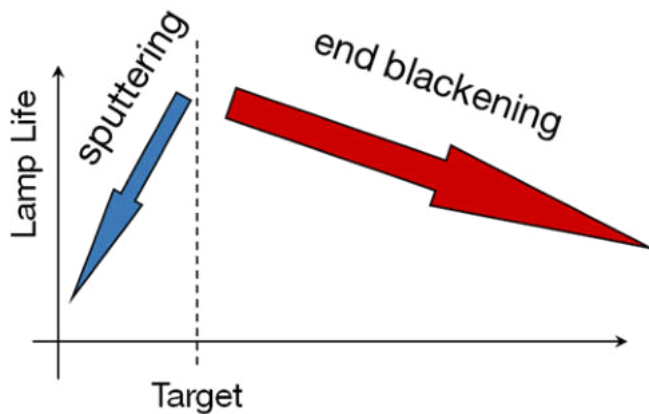

Generally speaking, it is not easy to measure the continuous heating current when the lamp is being operated on an electronic control gear (BAT) because of two reasons. First, the current is fed to the electrodes in the lamp via the two lead wires in a split that depends on the design of the control gear. Second, the lamp current and the auxiliary heating current may differ in phase, wave shape and frequency. Therefore it is not reasonable to specify the necessary auxiliary heating current as a function of the lamp current.

The important variable for electrode heating is the electrical heating power P_{Heat} fed to the electrode. As:

$$P_{Heat} = P_{Lamp\ current} + P_{Heating\ current} = f(I_d^2, I_{Heat}^2) \approx f(I_d^2 + I_{Heat}^2)$$

or

$$P_{Heat} \approx f(I_{Pin1}^2 + I_{Pin2}^2)$$

The necessary auxiliary heating current can also be specified as a function of lamp current by indicating the total of:

$$I_{Pin1}^2 + I_{Pin2}^2$$

which is called the “Sum of the Squares” of the pin current (SoS)

I_{Pin1} and I_{Pin2} are the two pin currents at an electrode in the lamp. I_{Pin1} and I_{Pin2} can be easily measured on electronic control gear.

As the diagram above shows, there is an ideal target setting for the sum of the squares of the two pin currents at which the lamp life will be at its optimum. If the sum of the squares of the pin currents decreases, sputtering will occur at the electrodes. As a result, lamp life will be drastically reduced.

If the sum of the squares of the pin currents increases with respect to the target value, end blackening gradually occurs and at very high values for heating the life of the lamp is gradually reduced due to high thermal evaporation of the emitter material.

The data are shown in the table below:

$$I_{Pin\ 1}^2 + I_{Pin\ 2}^2 / Target = -m_{Target} * I_d + b_{Target} = SoS_{Target}$$

$$I_{Pin\ 1}^2 + I_{Pin\ 2\ min}^2 = -m_{min} * I_d + b_{min} = SoS_{min}$$

$$I_{Pin\ 1}^2 + I_{Pin\ 2\ max}^2 = +m_{max} * I_d + b_{max} = SoS_{max}$$

Lamp	Minimum lamp current [A]	mTarget [A ² /A]	bTarget [A ²]	mmin [A ² /A] Y1 [A]	bmin [A ²] X1 [A ²]	mmax [A ² /A] Y2 [A]	bmax [A ²] X2 [A ²]	ILLmax [A]	ILLHmax [A]
OSRAM DULUX® S/E 7 W	0.015	0.072	0.030	0.240	0.030	0.061	0.040	0,137	0,182
OSRAM DULUX® S/E 9 W	0.015	0.072	0.030	0.240	0.030	0.061	0.040	0,137	0,182
OSRAM DULUX® S/E 11 W	0.015	0.072	0.030	0.240	0.030	0.061	0.040	0,137	0,182
OSRAM DULUX® D/E 10 W	0.015	0.078	0.035	0.260	0.035	0.066	0.045	0,147	0,196
OSRAM DULUX® D/E 13 W	0.015	0.078	0.035	0.260	0.035	0.066	0.045	0,147	0,196
OSRAM DULUX® D/E 18 W (XT)	0.020	0.105	0.065	0.350	0.065	0.089	0.080	0,200	0,266
OSRAM DULUX® D/E 26 W (XT)	0.030	0.171	0.175	0.570	0.175	0.146	0.210	0,326	0,434
OSRAM DULUX® T/E 13 W	0.015	0.078	0.035	0.260	0.035	0.066	0.045	0,147	0,196
OSRAM DULUX® T/E 18 W ₁₎	0.020	0.105	0.065	0.350	0.065	0.089	0.080	0,200	0,266
OSRAM DULUX® T/E 26 W ₁₎	0.030	0.171	0.175	0.570	0.175	0.146	0.210	0,326	0,434
OSRAM DULUX® T/E 32 W ₁₎ (XT)	0.030	0.171	0.175	0.570	0.175	0.146	0.210	0,326	0,434
OSRAM DULUX® T/E 42 W ₁₎ (XT)	0.030	0.171	0.175	0.570	0.175	0.146	0.210	0,326	0,434
OSRAM DULUX® T/E 11W HE	0.015	0.0693	0.028	0.231	0.028	0.059	0.032	0,130	0,170
OSRAM DULUX® T/E 14W HE	0.015	0.0693	0.028	0.231	0.028	0.059	0.032	0,130	0,170
OSRAM DULUX® T/E 17W HE	0.015	0.0693	0.028	0.231	0.028	0.059	0.032	0,130	0,170
OSRAM DULUX® L 18 W (XT, SP)	0.035	0.189	0.210	0.630	0.210	0.160	0.254	0,357	0,476
OSRAM DULUX® L 24 W (XT, SP)	0.035	0.189	0.210	0.630	0.210	0.160	0.254	0,357	0,476
OSRAM DULUX® L 36 W (XT, SP)	0.040	0.213	0.270	0.710	0.270	0.181	0.326	0,404	0,539
OSRAM DULUX® L 40 W ₁₎	0.035	0.189	0.210	0.630	0.210	0.160	0.254	0,357	0,476
OSRAM DULUX® L 55 W ₁₎ (XT)	0.050	0.279	0.450	0.930	0.450	0.235	0.550	0,525	0,700
OSRAM DULUX® L 80 W ₁₎	0.055	0.306	0.550	1.020	0.550	0.259	0.666	0,578	0,770
OSRAM DULUX® L 16 W HE	0.020	0,090	0,050	0,300	0,050	0,075	0,055	0,170	0,220
OSRAM DULUX® L 22 W HE	0.020	0,090	0,050	0,300	0,050	0,075	0,055	0,170	0,220
OSRAM DULUX® L 26 W HE	0.020	0,090	0,050	0,300	0,050	0,075	0,055	0,170	0,220
OSRAM DULUX® L 28 W HE	0.020	0,090	0,050	0,300	0,050	0,075	0,055	0,170	0,220
OSRAM DULUX® F 18 W	0.035	0.189	0.210	0.630	0.210	0.160	0.254	0,357	0,476
OSRAM DULUX® F 24 W	0.035	0.189	0.210	0.630	0.210	0.160	0.254	0,357	0,476
OSRAM DULUX® F 36 W	0.040	0.213	0.270	0.710	0.270	0.181	0.326	0,404	0,539
CFL SQUARE® 16W	0.015	0.072	0.030	0.240	0.030	0.037	0.061	0,136	0,182
CFL SQUARE® 28W	0.027	0.150	0.130	0.500	0.130	0.16	0.130	0,280	0,380
CFL SQUARE® 38W	0.040	0.234	0.320	0.780	0.320	0.390	0.195	0,440	0,590

1) Also for DULUX CONSTANT

The diagram shows an example of an OSRAM DULUX® D/E 26 W lamp.

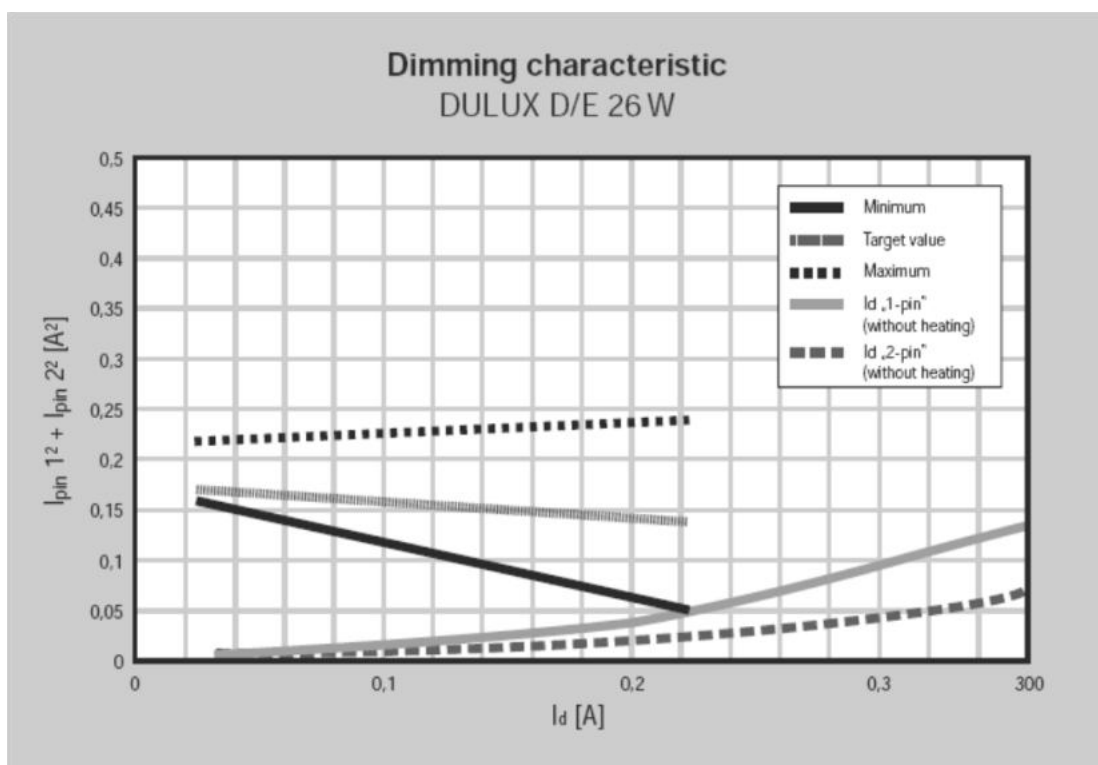

The $I_{d „1-pin“}$ and $I_{d „2-pin“}$ lines in the diagram show the discharge current for the two limiting cases.

1. The discharge current of the lamp is fed only via one lead wire
2. The discharge current of the lamp is fed equally via the two lead wires

The intersection of the curve with the line $I_{d „1-pin“}$ with $I_{pin 1}^2 + I_{pin 2}^2 \min$ (= minimum) gives the value of the minimum discharge current below which heating must be provided.

The optimum dimming operation would be along the target line. If there are any deviations toward smaller values for $I_{pin 1}^2 + I_{pin 2}^2$ the life of the lamp will be significantly reduced. If $I_{pin 1}^2 + I_{pin 2}^2$ is above the target value, blackening might be observed at the ends of the lamp. Proper lamp operation cannot take place below the „Minimum“ line or above the „Maximum“ line. Only burning duration tests can give a reliable indication of achievable lamp life in dimmer mode. These tests must be performed by the control gear manufacturers. Control gear manufacturers are also responsible for carrying out tests on the permissible ambient temperature ranges and on stability in dimmer mode.

For optimum operation, new lamps should be burnt in (seasoned) for 100 hours at full output before they are dimmed for the first time.

5.2 Magnetic operation

5.2.1 Magnetic operation 220 V/230V and 240V, 50Hz/60Hz

The following table shows the data for magnetic control gear for OSRAM DULUX® lamps.

Lamp DULUX®	Preheating									Ignition				
	Impedance Ω_{e}			Rated preheating current mA		Preheating current mA		Substitute resistance Ω_{e}			Open circuit voltage			
	At 220 V	At 230 V	At 240 V	Rated value at 220/230/240		min mA	max mA	At 220 V	At 230 V	At 240 V	220 V min Vrms	230 V min Vrms	240 V min Vrms	max VPeak
DS 5 W	1180	1240	1300	190	190	153	240	160	160	160	198	207	216	400
DS 7 W	1180	1240	1300	190	190	153	240	160	160	160	198	207	216	400
DS 9 W	1180	1240	1300	190	190	153	240	160	160	160	198	207	216	400
DS 11 W	1180	1240	1300	190	190	153	240	160	160	160	198	207	216	400
2 x DS 5 W	1070	1140	1210	190	190	153	240	320	320	320	198	207	216	400
2 x DS 7 W	1070	1140	1210	190	190	153	240	320	320	320	198	207	216	400
2 x DS 9 W	1070	1140	1210	190	190	153	240	320	320	320	198	207	216	400
DD 10 W	1070	1140	1210	210	210	153	275	100	100	100	198	207	216	440
DD 13 W	1070	1140	1210	210	210	153	275	100	100	100	198	207	216	440
DD 18 W	800	845	900	280	280	190	375	80	80	80	198	207	216	440
DD 26 W	540	571	610	420	420	270	550	25	25	25	198	207	216	440
DD ES 16W	800	845	900	280	280	190	375	80	80	80	198	207	216	440
DD ES 23W	540	571	610	420	420	270	550	25	25	25	198	207	216	440
DT 13 W ₃₎	1070	1140	1210	210	210	153	275	100	100	100	198	207	216	440
DT 18 W ₃₎	800	845	900	280	280	190	375	80	80	80	198	207	216	440
DT 26 W _{3) 4)}	540	571	610	420	420	270	550	25	25	25	198	207	216	440
DL 18 W	540	568	600	510	510	315	670	50	50	50	198	207	216	400
DL 24 W	540	568	600	510	510	315	670	50	50	50	198	207	216	400
DL 36 W	390	419	447	650	650	365	775	40	40	40	198	207	216	400
2 x DL 18 W (XT)	390	419	447	540	510	315	670	80	100	100	198	207	216	400
DF 18 W	540	568	600	510	510	315	670	50	50	50	198	207	216	400
DF 24 W	540	568	600	510	510	315	670	50	50	50	198	207	216	400
DF 36 W	390	419	447	650	650	365	775	40	40	40	198	207	216	400
2 x DF 18 W	390	419	447	540	510	315	670	80	100	100	198	207	216	400

- 1) For the calibration current of the reference control gear (see 2.2.2 and 2.2.3) Tolerance $\pm 3\%$.
- 2) Substitution resistance of both electrodes connected in series.
- 3) Control gear for OSRAM DULUX- D 13, 18 and 26 W can also be used to operate OSRAM DULUX- T 13, 18 and 26 W.
- 4) Also for CONSTANT model

5.3 Electrical data for the filaments

The electrode or filament is an extremely important component of a fluorescent lamp.

To operate the lamp at its optimum it is essential for the filament to be maintained within a particular temperature range. To ensure that this is the case even if control gear is operated with lamps from different manufacturers, the filament data are standardised.

The filament of a compact fluorescent lamp is defined such that the warm resistance R_T specified in the following table is in equilibrium when the specified test current flows through the filament. The cold resistance is not standardised and is shown here for the purposes of completeness only.

Lamp	Test current I_T mA	Warm resistance R_T at I_T Ω	Cold resistance R_0 measured at the pins Ω_{21}
OSRAM DULUX® S/E 7 W	130	50±12.5	11.1
OSRAM DULUX® S/E 9 W	130	50±12.5	11.1
OSRAM DULUX® S/E 11 W	130	50±12.5	11.1
OSRAM DULUX® D/E 10 W	140	50±12.5	11.1
OSRAM DULUX® D/E 13 W	140	50±12.5	11.1
OSRAM DULUX® D/E 18 W (XT)	190	26±6.5	6.2
OSRAM DULUX® D/E 26 W (XT)	310	13±3.25	3.3
OSRAM DULUX® T/E 13 W	140	50±12.5	11.1
OSRAM DULUX® T/E 18 W	190	26±6.5	6.2
OSRAM DULUX® T/E 26 W ₁₎	310	13±3.25	3.3
OSRAM DULUX® T/E 32 W ₁₎ (XT)	310	13±3.25	3.3
OSRAM DULUX® T/E 42 W ₁₎ (XT)	310	13±3.25	3.3
OSRAM DULUX® T/E 14W HE	120	50±12.5	11.1
OSRAM DULUX® T/E 14W HE	120	50±12.5	11.1
OSRAM DULUX® T/E 17W HE	120	50±12.5	11.1
OSRAM DULUX® L 18 W (XT, SP)	340	12±3.0	3.1
OSRAM DULUX® L 24 W (XT, SP)	340	12±3.0	3.1
OSRAM DULUX® L 36 W (XT, SP)	385	11±2.75	2.9
OSRAM DULUX® L 40 W ₁₎	340	12±3.0	3.1
OSRAM DULUX® L 55 W ₁₎ (XT)	500	8±2.0	2.3
OSRAM DULUX® L 80 W ₁₎	530	8±2.0	2.1
OSRAM DULUX® L 16 W HE	160	40 ± 10.0	8,4
OSRAM DULUX® L 22 W HE	160	40 ± 10.0	8,4
OSRAM DULUX® L 26 W HE	160	40 ± 10.0	8,4
OSRAM DULUX® L 28 W HE	160	40 ± 10.0	8,4
OSRAM DULUX® F 18 W	340	12±3.0	3.1
OSRAM DULUX® F 24 W	340	12±3.0	3.1
OSRAM DULUX® F 36 W	385	11±2.75	2.9
CFL SQUARE® 16W	130	64±16.0	13,5
CFL SQUARE® 28W	270	17.5±4.4	3,7
CFL SQUARE® 38W	420	9±2.25	1,9

1) Also for DULUX CONSTANT

2) Guide value

6 Accessories

6.1 Caps and lampholders

OSRAM DULUX® lamps from the various ranges and compatible lamps from other manufacturers have different caps, some of which are also coded differently. This prevents the wrong type of lamp from being used. Using the wrong lamp in a light fitting impairs the safety of the system, often constitutes a fire risk and leads in most cases to premature lamp failure. It is also important, however, to follow the instructions of the luminaire manufacturer in selecting the right lamp. This applies in particular to cases where the same cap/lampholder system is used for two or more lamps (e.g. GX24q-3 for OSRAM DULUX® T/E 26 W and 32 W, 2G11 for OSRAM DULUX® L 18 W to 80 W and 2G10 for OSRAM DULUX® F 18 W to 36 W). In the case of OSRAM DULUX® S and OSRAM DULUX® S/E 5 W to 11 W, there is no need to code the G23 or 2G7 caps owing to the minimal differences between the wattages.

Lampholders have a dual role in that they supply power to the lamp and hold the lamp in position. They must also be able to withstand high temperatures. The quality of the lampholder is therefore an important aspect. Another factor to bear in mind is that the lampholder must be strong enough to withstand the stresses involved in removing old lamps and inserting new lamps several times during the lifetime of the light fitting. The various OSRAM DULUX® caps and their coding are listed below for diagrams see 2.1 Geometric data (p. 24).

Lamp	Cap		Starter	Coding
OSRAM DULUX® S 5, 7, 9, 11 W	G23	2-pin	integrated	none
OSRAM DULUX® S/E 7, 9, 11 W	2G7	4-pin	none	none
OSRAM DULUX® D 10, 13 W	G24d-1	2-pin	integrated	1 bar central
OSRAM DULUX® D 18 W, D ES 16W	G24d-2	2-pin	integrated	1 bar left
OSRAM DULUX® D 26 W, D ES 23W	G24d-3	2-pin	integrated	1 bar right
OSRAM DULUX® D/E 10, 13 W	G24q-1	4-pin	none	1 bar central, short guidepost ₁
OSRAM DULUX® D/E 18 W (XT)	G24q-2	4-pin	none	1 bar left, short guidepost ¹⁾
OSRAM DULUX® D/E 26 W (XT)	G24q-3	4-pin	none	1 bar right, short guidepost ₁
OSRAM DULUX® T 13 W	GX24d-1	2-pin	integrated	1 bar central, compatible with G24d-1
OSRAM DULUX® T 18 W	GX24d-2	2-pin	integrated	1 bar left, compatible with G24d-2
OSRAM DULUX® T 26 W ₂	GX24d-3	2-pin	integrated	1 bar right, compatible with G24d-3
OSRAM DULUX® T/E 13 W ₂	GX24q-1	4-pin	none	1 bar central, short guidepost ₁ , compatible with G24q-1
OSRAM DULUX® T/E 18 W ₂	GX24q-2	4-pin	none	1 bar left, short guidepost ₁ , compatible with G24q-2
OSRAM DULUX® T/E 26 W, 32 W ₂ (XT)	GX24q-3	4-pin	none	1 bar right, short guidepost ₁ , compatible with G24q-3
OSRAM DULUX® T/E 42 W ₂ (XT)	GX24q-4	4-pin	none	2 bars central, short guidepost ₁
OSRAM DULUX® T/E 11, 14, 17W HE	GR14q-1	4-pin	none	
OSRAM DULUX® L 18 ₃ , 24 ₃ , 36 ₃ , 40 ₂ , 55 ₂ , 80 ₂ W (XT)	2G11	4-pin	none	Coding is as per IEC 60901 in connection with a lamp holder at the prescribed distance from the reference level (see 6.2)
OSRAM DULUX® L 16, 22, 26, 28W HE	2GX11	4-pin	none	
OSRAM DULUX® F 18, 24, 36 W	2G10	4-pin	none	None
OSRAM CFL SQUARE® 16, 28W	GR8	2-pin	Integrated	None
OSRAM CFL SQUARE® 16, 28, 38W	GR10q	4-pin	none	None

1) Lamps will still fit in old „deep“ holders.

2) Also for CONSTANT

3) Also for SP model

OSRAM DULUX- bases and their coding pictograms are listed in the chapter 2.1 Geometric data (p.24).

6.2 Lamp supports

OSRAM DULUX® L lamps require a lamp support. The distance between the lamp support and the reference plane of the lamp is defined in the IEC 60901 standard and is given in the table below.

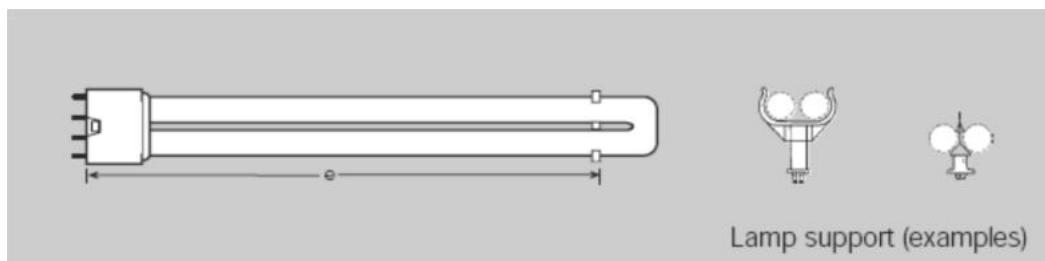

Distance from reference plane e

Lamp	Minimum mm	Maximum mm
OSRAM DULUX® L 18 W (XT, SP)	140	175
OSRAM DULUX® L 24 W (XT, SP) and L HE 16 W	140	270
OSRAM DULUX® L 36 W (XT, SP) and L HE 22 W	330	365
OSRAM DULUX® L 40 W ₁ , 55 W ₁ (XT) and L HE 26 W	450	485
OSRAM DULUX® L 80 W ₁ and L HE 28 W	480	515

1) Also for CONSTANT models

Lamp supports are optional for other OSRAM DULUX® lamps, such as OSRAM DULUX® F.

Information for light fitting manufacturers:

The use of metallic lamp supports is not recommended. A use of such may lead to deviated lamp properties under both, normal and dimming operation.

6.3 Starters

In magnetic operation, OSRAM DULUX® L (18W, 24W and 36W only) and OSRAM DULUX® F lamps require a starter for ignition. There is a choice of conventional glow starters or such that are known as safety starters, e.g. the OSRAM DEOS® starters. Conventional glow starters should be replaced whenever lamps are replaced to ensure trouble-free ignition. This is not necessary with safety starters since they last four times longer than conventional starters. In addition, safety starters reliably shut down burnt-out or defective lamps in inductive or capacitive operation, which not only saves the magnetic ballast but prevents annoying flicker from these lamps as they reach the end of their life.

OSRAM DULUX® S, D, T and CFL SQUARE (with two-pin bases) have a specially adapted glow starter integrated in the base which ensures reliable ignition. Therefore they do not require external starters. OSRAM DULUX® S/E, D/E and T/E (with four-pin bases) are designed for ECG operation and do therefore not have an integrated glow starter.

OSRAM DULUX® S/E, D/E and T/E (13, 18 and 26 W only) can be operated under normal conditions with magnetic control gear and an external starter. However, there are no special optimised starters available on the market for this application. See also 3.2.3. In this mode, considerable limitations can therefore be expected, such as greatly reduced lamp life with electrode blackening and longer ignition times. For this reason, this mode of operation is not recommended or supported by OSRAM.

For the operation of the OSRAM CFL SQUARE 4-pin with magnetic control gear and external starter the OSRAM ST 111 Longlife starter is suitable. For starters from different manufacturers the following parameters have to be respected.

In general an external starter has to be replaced together with a failed 4-pin lamp. Exceptions are all DEOS starter types.

Information for starter design for the OSRAM CFL SQUARE® 4-pin

Lamp type	Pulse voltage	Non-reclosure voltage	RIS capacitor	
	V	V	nF	nF
	Minimum		Minimum	Maximum
16W	500*	130	1.0	3.0
28W, 38W	500*	130	5.0	8.0

7 Measuring OSRAM DULUX® compact fluorescent lamps

OSRAM DULUX® lamps differ, in some cases quite considerably, from double capped fluorescent lamps in terms of their technical characteristics. In measurements, therefore, particular attention should be paid to the following (see also IEC 60901):

1. Defined ageing (seasoning) of the lamp (**100 hours**)
2. Adequate burn-in time (stabilization) before measurements are taken (**24 hours**, and see measurement steps under 7.1, p. 90)
3. Constant T_a (ambient temperature) during the measurements ($25 \pm 1^\circ\text{C}$)
4. No destabilization due to mechanical vibrations, even when switched off
5. High crest factor resolution for measurement equipment (true rms instruments).
6. Short mains supply and measurement instrument wiring to the lamp (for ECG operation)

If these conditions are met, OSRAM DULUX® lamps display good reproducibility of electrical and photometric values. Reference lamps measured under the following conditions can be obtained from OSRAM (see 7.6, p. 93).

7.1 Ageing of lamps

Before photometric data is gathered, new lamps should be aged (seasoned) for 100 hours.

During shipping and normal handling of the lamps, e.g. rotating of the lamp, any excess amount of mercury may be distributed in small droplets within the discharge tube. Proper conditioning is reached when all the excess mercury has been collected at the coldest spot in the tube. Experience has shown that initially this process of lamp conditioning may take up to 24 h. When a lamp, once having passed this conditioning period it is ready for measurement

For conditioning and warming up the lamp may be operated in a location, distant to the test location. When moving to the test location, provided that the lamp has been kept in the same position and not subjected to vibration or shock and no warm glass parts are touched (i.e. creating a parasitic cold spot). Before moving an amalgam lamp to the test location let the lamp cool down for 1 min in the burning position. A stabilisation period of 15 – 60 minutes (see table) is necessary in the test location. To avoid cooling down of warm glass parts during moving the lamp to test location thermally insulating gloves or similar technique shall be used. The interruption of the supply should be as short as possible.

Measurement of light output and lamp operating voltage must be taken at least once per minute. During the final 5 minutes of stabilisation time, the difference of maximum and minimum readings of light output and lamp operating voltage shall be less than 1% of the average of the readings. If this is not feasible, the real fluctuation shall be stated.

Stabilisation time versus off time

Conditioning (can be part of aging)	[h]	24	
Off time (transport to test location)	[min]	< 5	> 5
Stabilisation time	[min]	15	60

7.2 Operating position

Free-operating OSRAM DULUX® S, S/E, D (ES), D/E (XT), T (XT, CONSTANT), T/E (XT, HE, CONSTANT) lamps are measured in the base-up position, OSRAM DULUX® L (SP, XT, HE, CONSTANT), F and CFL SQUARE® are measured in horizontal operating position. All measurements are according to IEC.

7.3 Constant photometric values

Aged and stabilised OSRAM DULUX® lamps provide reproducible photometric data at constant ambient temperature and in an unchanged operating position. Fluctuations are less than 1 % of the upper range value.

7.4 Electrical measurements

All the cables, control gear and instruments must be arranged, and if necessary shielded, so that there is no chance of interference from external fields. Use instruments which will supply the level of accuracy required in the measured values.

Recommendations

Instruments:

Rms instruments (true RMS)

Accuracy: ±0.2% of the measuring range

Area of application

Frequency: 0-500 Hz (CCG) scanning rate

0-400 kHz (ECG) scanning rate

Crest factor: > 2 (CCG)

> 3 (ECG)

Lamp supply:

Supply voltage: Depending on the lamp and control gear (magnetic, electronic or reference device)

Stability: ± 0.2% during the measurement

Total harmonic distortion: < 3%

Suitable supply:

- Noise-free mains
- Electronically Regulated stabilisers
- Rotary measuring generators
- Electronic generators

The apparent power of supply unit should be five times the rated system power.

7.5 Temperature measurements

The luminous flux and hence the luminous efficacy of OSRAM DULUX® lamps depend on the temperature. To achieve optimum operating conditions for the lamp in the luminaire, it is therefore essential to know either the ambient temperature in the vicinity of the lamp or the cold spot temperature directly on the lamp.

7.5.1 Ambient temperature

Unless otherwise indicated, the lamp data in this guide is based on an ambient temperature of 25°C ± 1°C in draught free air in accordance with IEC 60901. Lamp data as a function of actual ambient temperature or cold spot temperature is also measured in draught free air.

7.5.2 Cold spot temperature for lamps without amalgam

The cold spot temperatures are dependent on the operating position and lie approximately in the range from 40°C to 50°C (optimum operating conditions). In the base-up operating position and no air circulation, temperature measuring point 3 (see 4.8, p. 71 – Lamp temperatures and limit values) generally corresponds to the cold spot. The cold spot can however shift as a result of a different operating position or other influences.

Measuring point 3 (cold spot temperature in base-up operating position) is defined for OSRAM DULUX® lamps at the outer lamp arc, centred on the bulb – except CFL SQUARE® (see 4.8, p. 71). To determine the temperature at measuring point 3 (not in the case of the CONSTANT version and CFL SQUARE®) thermocouples (NiCr-Ni thermo-elements) are fixed with a neutral, translucent adhesive.

To avoid an accidental release of the thermocouple, it is highly recommended to secure it with a small transparent cable tie (temperature resistance of the material > 120°C) throughout the whole measurement. Refer to the picture below.

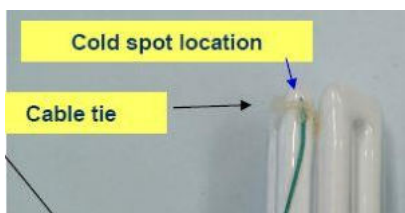
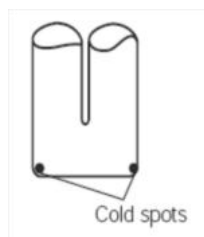

7.5.3 Measuring CONSTANT lamps

CONSTANT lamps are designed for a wide temperature range. They therefore achieve their optimum operating conditions (>90% of rated luminous flux) in the temperature range from 5°C to 70°C. If photometric measurements are taken under reference conditions (an ambient temperature of 25°C, see 7.5.1), it must be remembered that the measured luminous flux may be up to 10% below the maximum luminous flux that the lamp can produce. Please refer to the luminous flux/ambient temperature relation graphs (4.6) for detailed information.

In case of horizontal operation of quad and multilimbed lamps it has to be noted that the luminous flux as a function of ambient temperature also depends on the location of the electrodes (above or below the symmetry plane of the lamp).

7.6 Reference lamps

Reference lamps (luminous flux and electrical values) can be obtained from the accredited test laboratory of OSRAM GmbH (DAR register number: DAT-P-043/94-00, Lighting Technology).

DULUX® T/E CONSTANT and CFL SQUARE® lamps for measurements are also available with thermocouples fixed at the measuring point.

For prices and delivery times please contact:

OSRAM GmbH
Dept./BU: PL PLM TLS PS&S EU&LA&ME
Hellabrunner Str. 1
81536 Munich

Tel.: (+49) 89 6213-2604

Fax.: (+49) 89 6213-4052

8 OSRAM DULUX® and the environment

8.1 Contents

Like all discharge lamps, OSRAM DULUX® lamps are sealed systems, if used as prescribed. Therefore they do not have any effect on the environment apart from emitting light. The most important substance in discharge lamps as far as the environment is concerned is mercury. Discharge lamps must contain some mercury in order to generate light. By using a patented dosing procedure, OSRAM has succeeded in reducing the amount of mercury in most models to the currently minimum needed to guarantee reliable operation of around 1.3 mg per lamp.

8.2 Waste disposal



WEEE (Waste Electrical and Electronic Equipment) regulations state that in the EU since July 1, 2005 all old electrical equipment including failed discharge lamps must be sent for proper recycling. For private consumers this means that they will have to hand the old lamps in to local recycling centres free of charge.

In the B2B sector (Business to Business), discharge lamps with mercury residue qualify as waste requiring special supervision (special waste code) with a corresponding duty to dispose them carefully. This applies for example to mercury vapour lamps and (compact) fluorescent lamps.

In Germany this is, today, regulated by the “Kreislaufwirtschaftsgesetz“ and its legislation.

All the above-mentioned lamps affected by the WEEE regulations have a symbol on the packaging showing a dustbin with a line through it.

8.3 ROHS Directive and conformity for compact fluorescent lamps

RoHS Declaration Compact Fluorescent Lamps

Edition: 06/2006

OSRAM DULUX compact fluorescent lamps are low-pressure discharge lamps that operate on the following principle: After ignition, mercury vapour in the glass tube emits UV radiation. This radiation is converted by the phosphors on the inside of the glass tube into visible light, in a light colour that depends on the phosphors used.

A control gear ensures the correct luminous flux is emitted. On DULUX EL lamps the control gear is integrated in the lamp casing, whereas external control gear is needed for DULUX D, T/E, S, L, LSP and F lamps. The phosphors used are fully annealed inert substances that pose no risk to health even if they are released as a result of a lamp breakage.

When the lamp is in new condition the mercury is present in the form of a small mercury/iron compact in the discharge vessel (bulb). When the lamp is switched on the mercury vaporises as the temperature of the bulb rises, and the mercury vapour needed for the discharge fills the entire bulb. Mercury is released if the lamp breaks.

We hereby confirm that our products, put on the European Union market by OSRAM after July 1, 2006, are fully compliant with the requirements of the European Directive 2002/95/EC "on the restriction of the use of certain hazardous substances in electrical and electronic equipment" (RoHS) of January 27th, 2003.

The allowable limits listed in the RoHS directive for compact fluorescent lamps are as follows:

Substances	Allowable limit
Pb	0,1%
Cd	0,01%
Hg	5mg/lamp
Cr ⁶⁺	0,1%
PBB	0,1%
PBDE	0,1%

Please note: since starters for compact fluorescent lamps are considered electronic components they do not fall under the RoHS directive.

For your kind reference, RoHS web page of the European Union:
http://europa.eu.int/eur-lex/pri/en/oj/dat/2003/l_037/l_03720030213en00190023.pdf

OSRAM contact address:

If you have any queries regarding environmental protection at OSRAM please contact our department:
Environmental Affairs & Technical Safety

Tel. +49-89-6213 3309; Fax: +49-89-6213 3463; Email: infoline@osram.com

Dr. Ralf M. Criens
ES-M
Senior Director Environmental Affairs
and Technical Safety

Dr. Rüdiger Klam
R&D-M
Vice President Research
and Development

Subject to change

SEE THE WORLD IN A NEW LIGHT



9 European and international standards

9.1 Relevant standards

9.1.1 Lamps and caps

OSRAM DULUX® lamps comply with all relevant European and international standards listed in the following table (see also 9.2 Declaration of Conformity).

	German	European	International
Single-capped fluorescent lamps Performance – specifications	DIN EN 60901 (VDE 0715 Partl 7)	EN 60901	IEC 60901
Single-capped fluorescent lamps Safety specifications	DIN EN 61199 (VDE 0715 Part 9)	EN 61199	IEC 61199
Lamp caps and holders together with gauges for the control of interchangeability and safety	DIN EN 60061	EN 60061	IEC 60061
Part 1: Lamp caps	DIN EN 60061-1	EN 60061-1	IEC 60061-1

9.1.2 Accessories

The following table shows the most important standards that apply to accessories.

Accessories relevant standards	German	European	International
Lamp caps and holders together with gauges for the control of interchangeability and safety	DIN EN 60061-1	EN 60061-1	IEC 60061-1
Part 2: Lampholders	DIN EN 60061-2	EN 60061-2	IEC 60061-2
Part 3: Gauges	DIN EN 60061-3 Band I und II	EN 60061-3	IEC 60061-3
Part 4: Guidelines and general information	DIN EN 60061-4	EN 60061-4	IEC 60061-4
Glow starters for fluorescent lamps	DIN VDE 0712 Part 101	EN 60 155	IEC 60155
Ballasts for tubular fluorescent lamps General and safety requirements	DIN EN 60 920 (VDE 0712 Part 10)	EN 60 920	IEC 60920
Ballasts for tubular fluorescent lamps Performance requirements	DIN EN 60 921 (VDE 0712 Part 11)	EN 60 921	IEC 60921
DC-supplied electronic control gear for tubular fluorescent lamps General and safety requirements	DIN EN 60 924 (VDE 0712 Part 20)	EN 60 924	IEC 60924
AC-supplied electronic ballasts for tubular fluorescent lamps General and safety requirements	DIN EN 60 928 (VDE 0712 Part 22)	EN 60 928	IEC 60928
AC-supplied electronic ballasts for tubular fluorescent lamps Performance requirements	DIN EN 60 929 (VDE 0712 Part 23)	EN 60 929	IEC 60929

Accessories relevant standards	German	European	International
Electromagnetic compatibility (EMC) Section 2: Limits for harmonic currents emissions (Equipment input current \geq 16A per phase)	DIN EN 61000-3-2 (VDE 0838 Part 2)	EN 61000-3-2	IEC 1000-3-2
Capacitors for use in tubular fluorescent and other discharge lamp circuits General and safety requirements	DIN EN 61 048 (VDE 0560 Part 61)	EN 61 048	IEC 61048
Capacitors for use in tubular fluorescent and other discharge lamp circuits Performance requirements	DIN EN 61049 (VDE 0560 Part 62)	EN 61 049	IEC 61049

9.1.3 Luminaires

The following table shows the most important standards that apply to luminaires.

Luminaires relevant standards	German	European	International
Suppression of radio disturbances caused by electrical appliances and systems; limits and methods of measurement of radio disturbance characteristics of electrical lighting and similar equipment	DIN EN 55015 VDE 0875 Part 15	EN 55015	CISPR 15
Equipment for general lighting purposes, EMC immunity requirements	DIN EN 61547	EN 61547	IEC 61547
Luminaires	DIN EN 60598	EN 60598	IEC 60598
Part 1: General requirements and tests	DIN EN 60598-1 (VDE 0711 Part 1)	EN 60 598-1	IEC 60598-1
Fixed general purpose luminaires purpose luminaires	DIN VDE 0711 Part 201	EN 60 598-2-1	IEC 60598-2-1
Recessed luminaires	DIN VDE 0711 Part 202	EN 60 598-2-2	IEC 60598-2-2
Luminaires for road and street lighting	DIN EN 60 598-2-3 (VDE 0711 Part 203)	EN 60 598-2-3	IEC 60598-2-3
Portable general purpose luminaires	DIN EN 60 598-2-4 (VDE 0711 Part 204)	EN 60 598-2-4	IEC 60598-2-4
Floodlights	DIN VDE 0711 Part 205	EN 60 598-2-5	IEC 60598-2-5
Luminaires with built-in transformers for filament lamps	DIN EN 60598-2-6 (VDE 0711 Part 206)	EN 60 598-2-6	IEC 60598-2-6
Portable luminaires for garden use	DIN EN 60598-2-7 (VDE 0711 Part 207)	EN 60 598-2-7	IEC 60598-2-7
Handlamps	DIN VDE 0711 Part 208	EN 60 598-2-8	IEC 60598-2-8
Photo and film luminaires (non-professional)	DIN EN 60 598-2-9 (VDE 0711 Part 9)	EN 60 598-2-9	IEC 60598-2-9
Portable child-appealing luminaires	DIN EN 60598-2-10 (VDE 0711 Part 210)	EN 60 598-2-10	IEC 60598-2-10
Luminaires for stage lighting, television and film studios (outdoor and indoor)	DIN VDE 0711 Part 217	EN 60 598-2-17	IEC 60598-2-17
Luminaires for swimming pools and similar applications	DIN EN 60 598-2-18 VDE 0711 Part 218	EN 60 598-2-18	IEC 60598-2-18
Air-handling luminaires (safety requirements)	DIN EN 60 598-2-19 VDE 0711 Part 2-19	EN 60 598-2-19	IEC 60598-2-19
Lighting chains	DIN EN 60 598-2-20 VDE 0711 Part 2-20	EN 60 598-2-20	IEC 60598-2-20

Luminaires relevant standards	German	European	International
Luminaires for emergency lighting	DIN EN 60 598-2-22 VDE 0711 Part 2-22	EN 60 598-2-22	IEC 60598-2-22
Luminaires for use in clinical areas of hospitals and health care buildings	DIN EN 60598-2-25 VDE 0711 Part 225	EN 60 598-2-25	IEC 60598-2-25
Electrical supply track systems for luminaires	DIN EN 60570 VDE 0711 Part 300	EN 60 570	IEC 60570
Dental equipment Dental operating light	E DIN EN	pr EN ISO ISO 9680	ISO 9680 9680
Specifications for lighting fittings with service voltages below 1000 V	DIN VDE 0710	not yet available	not yet available
General requirements	DIN VDE 0710 Part 11)	not yet available	not yet available
Special provisions for lamps operated under adverse conditions	DIN VDE 0710 Part 41)	not yet available	not yet available
Specification rules for flush-fitting signal-light fittings	DIN VDE 0710 Part 111)	not yet available	not yet available
Luminaires for aquariums	DIN VDE 0710 Part 121)	not yet available	not yet available
To ball throwing luminaires safety	DIN VDE 0710 Part 131)	not yet available	not yet available
Luminaires for building-in furniture	DIN VDE 0710 Part 141)	not yet available	not yet available

¹⁾ Existing German standard for which there is currently no international counterpart.

9.1.4 Miscellaneous

	German	European	International
International Lamp Coding System (ILCOS) See also 10.	DIN 49805	–	IEC TS 61231

9.1.5 Sources

Standards can be obtained from

	Publisher	Sales office
DIN Deutsche Normen	DIN Deutsches Institut für Normung e.V. Burggrafenstraße 6 D - 10787 Berlin	Beuth Verlag GmbH D - 10772 Berlin
DIN VDE Normen	DIN Deutsches Institut für Normung e.V. Burggrafenstraße 6 D - 10787 Berlin	Beuth Verlag GmbH D - 10772 Berlin VDE-Verlag GmbH Bismarckstr. 33 D - 10625 Berlin
IEC Standards	IEC Central Office 3, rue Varembe CH - 1211 Genf	Beuth Verlag GmbH 10772 Berlin VDE-Verlag GmbH Bismarckstr. 33 D - 10625 Berlin

9.2 Declaration of Conformity

EC-Declaration of Conformity



Document number: 2011-31 10 DC 1/4
Manufacturer or representative: OSRAM AG
Address: Hellabrunner Straße 1
81543 München
Germany
Brand name or trade mark: OSRAM
Product type: Single-capped fluorescent lamp
Product designation: OSRAM DULUX T and T/E
 See attached list

The designated product(s) is (are) in conformity with the provisions of the following European Directives.

- 2006/95/EC** and amendments **Directive of the European Parliament and of the Council of 12 December 2006 on the harmonisation of the laws of Member States relating to electrical equipment designed for use within certain voltage limits**
- 2004/108/EC** and amendments **Directive of the European Parliament and of the Council of 15 September 2004 on the approximation of the laws of the Member States relating to electromagnetic compatibility**
- 2009/125/EC** and amendments **Directive of the European Parliament and of the Council of 21 October 2009 establishing a framework for the setting of ecodesign requirements for energy-related products**
- 244/2009** and amendments **Commission Regulation (EC) implementing Directive 2005/32/EC of the European Parliament and of the Council with regard to ecodesign requirements for non-directional household lamps**
- 245/2009** and amendments **Commission Regulation (EC) implementing Directive 2005/32/EC of the European Parliament and of the Council with regard to ecodesign requirements for fluorescent lamps without integrated ballast, for high intensity discharge lamps, and for ballasts and luminaires able to operate such lamps, and repealing Directive 2000/55/EC of the European Parliament and of the Council**
-

Further information regarding compliance with these Directives is given in the **annex** which constitutes a part of this declaration.

Last two digits of the year in which the CE marking was affixed: 11

Place and date of signatures: Augsburg, 03.11.2011

Signatures:  
Quality Management Quality Assurance
Names: Dr. Dieter Wahl Rolf Frenzel

This declaration of conformity is issued under the sole responsibility of the manufacturer. It certifies compliance with the indicated Directives, but implies no warranty of properties.

EC-Declaration of Conformity Annex

Document number: 2011-31 10 DC

The conformity of the designated product(s) with the provisions of the European Directive **2006/95/EC** is given by the compliance with the following European Standard(s). If not elsewhere/otherwise indicated the edition/amendment as referenced below applies.

- | | | |
|-------------------------------------|--|---|
| <input type="checkbox"/> | EN 60155:
1995 + A1:1995 +
A2:2007 | Glow-starters for fluorescent lamps |
| <input type="checkbox"/> | EN 60432-1:
2000 + A1:2005 | Incandescent lamps — Safety specifications — Part 1: Tungsten filament lamps for domestic and similar general lighting purposes |
| <input type="checkbox"/> | EN 60432-2:
2000 + A1:2005 | Incandescent lamps — Safety specifications — Part 2: Tungsten halogen lamps for domestic and similar general lighting purposes |
| <input type="checkbox"/> | EN 60432-3:
2003 + A1:2005 +
A2:2008 | Incandescent lamps — Safety specifications — Part 3: Tungsten halogen lamps (non-vehicle) |
| <input type="checkbox"/> | EN 60598-1:
2008 + A11:2009 | Luminaires — Part 1: General requirements and tests |
| <input type="checkbox"/> | EN 60598-2-1:
1989 | Luminaires — Part 2-1: Particular requirements — Fixed general purpose luminaires |
| <input type="checkbox"/> | EN 60598-2-2:
1996 + A1:1997 | Luminaires — Part 2-2: Particular requirements — Recessed luminaires |
| <input type="checkbox"/> | EN 60598-2-3:
2003 + A1:2011 | Luminaires — Part 2-3: Particular requirements — Luminaires for road and street lighting |
| <input type="checkbox"/> | EN 60598-2-4:
1997 | Luminaires — Part 2-4: Particular requirements — Portable general purpose luminaires |
| <input type="checkbox"/> | EN 60598-2-5:
1998 | Luminaires — Part 2-5: Particular requirements — Floodlights |
| <input type="checkbox"/> | EN 60598-2-6:
1994 + A1:1997 | Luminaires — Part 2-6: Particular requirements — Luminaires with built-in transformers for filament lamps |
| <input type="checkbox"/> | EN 60598-2-7:
1989 + A2:1996 +
A13:1997 | Luminaires — Part 2-7: Particular requirements — Portable luminaires for garden use |
| <input type="checkbox"/> | EN 60598-2-8:
1997+ A1:2000 +
A2:2008 | Luminaires — Part 2-8 : Particular requirements — Handlamps |
| <input type="checkbox"/> | EN 60598-2-10:
2003 | Luminaires — Part 2-10: Particular requirements — Portable luminaires for children |
| <input type="checkbox"/> | EN 60598-2-13:
2006 | Luminaires — Part 2-13: Particular requirements — Ground recessed luminaires |
| <input type="checkbox"/> | EN 60598-2-20:
2010 | Luminaires — Part 2-20: Particular requirements — Lighting chains |
| <input type="checkbox"/> | EN 60968:
1990 + A1:1993 +
A2:1999 | Self-ballasted lamps for general lighting services — Safety requirements |
| <input type="checkbox"/> | EN 61195:
1999 | Double-capped fluorescent lamps — Safety specifications |
| <input checked="" type="checkbox"/> | EN 61199:
1999 | Single-capped fluorescent lamps — Safety specifications |
| <input type="checkbox"/> | EN 61347-1:
2008 + A1:2011 | Lamp controlgear — Part 1: General and safety requirements |

- | | | |
|-------------------------------------|---|---|
| <input type="checkbox"/> | EN 61347-2-2:
2001 + A1:2006 +
A2:2006 | Lamp controlgear — Part 2-2: Particular requirements for d. c. or a. c. supplied electronic step-down convertors for filament lamps |
| <input type="checkbox"/> | EN 61347-2-3:
2001+A1:2004 +
A2:2006 | Lamp controlgear — Part 2-3: Particular requirements for a. c. supplied electronic ballasts for fluorescent lamps |
| <input type="checkbox"/> | EN 61347-2-12:
2005 + A1:2010 | Lamp controlgear — Part 2-12: Particular requirements for d. c. or a. c. supplied electronic ballasts for discharge lamps (excluding fluorescent lamps) |
| <input type="checkbox"/> | EN 61347-2-13:
2007 | Lamp controlgear — Part 2-13: Particular requirements for d. c. or a. c. supplied electronic controlgear for LED modules |
| <input type="checkbox"/> | EN 61549:
2003 + A1:2005 +
A2:2010 | Miscellaneous lamps |
| <input type="checkbox"/> | EN 62031:
2008 | LED modules for general lighting — Safety specifications |
| <input type="checkbox"/> | EN 62035:
2000 + A1:2003 | Discharge lamps (excluding fluorescent lamps) — Safety specifications |
| <input checked="" type="checkbox"/> | EN 62471:
2008 | Photobiological safety of lamps and lamp systems |
| <input type="checkbox"/> | IEC/TR 62471-2:
2009 | Photobiological safety of lamps and lamp systems — Part 2: Guidance on manufacturing requirements relating to non-laser optical radiation safety |
| <input type="checkbox"/> | EN 62493:
2010 | Assessment of lighting equipment related to human exposure to electromagnetic fields |
| <input type="checkbox"/> | EN 62532:
2011 | Fluorescent induction lamps — Safety specifications |
| <input type="checkbox"/> | EN 62560:
XXXX | Self-ballasted LED-lamps for general lighting services by voltage > 50 V — Safety specifications |
| <input type="checkbox"/> | | |
| <input type="checkbox"/> | | |

The conformity of the designated product(s) with the provisions of the European Directive **2004/108/EC** is given by the compliance with the following European Standard(s). If not elsewhere/otherwise indicated the edition/amendment as referenced below applies.

- | | | |
|-------------------------------------|---|--|
| <input checked="" type="checkbox"/> | EN 55015:
2006 + A1:2007
+ A2:2009 | Limits and methods of measurement of radio disturbance characteristics of electrical lighting and similar equipment |
| <input type="checkbox"/> | EN 61000-3-2:
2006 + A1:2009
+ A2:2009 | Electromagnetic compatibility (EMC) — Part 3-2: Limits — Limits for harmonic current emissions (equipment input current ≤ 16 A per phase) |
| <input type="checkbox"/> | EN 61000-3-3:
2008 | Electromagnetic compatibility (EMC) — Part 3-3: Limits — Limitation of voltage changes, voltage fluctuations and flicker in public low voltage supply systems, for equipment with rated current ≤ 16 A per phase and not subjected to conditional connection |
| <input type="checkbox"/> | EN 61547:
2009 | Equipment for general lighting purposes — EMC immunity requirements |
| <input type="checkbox"/> | | |
-

EC-Declaration of Conformity
Attached list

Document number: 2011-31 10 DC

OSRAM DULUX T PLUS for CCG

13W / 18W / 26W

OSRAM DULUX T/E PLUS for ECG

13W / 18W / 26W / 32W / 42W

OSRAM DULUX T/E CONSTANT for ECG

26W / 32W / 42W

OSRAM DULUX T/E HE HIGH EFFICIENCY for ECG

11W / 14W / 17W

OSRAM DULUX T/E XT for ECG

32W / 42W

9.3 CE labelling



The CE label on OSRAM DULUX® packaging and on the declarations of conformity indicates compliance with low-voltage guidelines (safety requirements in accordance with EN 61199).

Here are some points to bear in mind about CE labelling:

The CE label is intended first and foremost for administrative authorities, not end users.

The CE label is mandatory for the sale of products that can be used independently within the EU.

It is purely an administrative label. It is not a seal of quality or approval mark.

The CE label is based on the declaration of conformity issues by manufacturers on their own responsibility. It is not based on testing by a recognised independent inspectorate.

The CE label acts as a passport. It promotes free trade within Europe.

The European directive 245/2009 with respect to energy using products (ErP) is part of the CE requirements starting March 2009.

9.4 Energy Efficiency Index

Commission Directive 98/11/EC: Energy labelling for Household Lamps: The EEI (Energy Efficiency Index, e.g. EEI = A), also known as the „energy label“, classifies lamps according to their energy efficiency (it does not relate to luminaires).

Directive 98/11/EC for implementing Directive 92/75/EEC has been in force since April 1998.

The seven classes are defined by certain limit values in lamp output. Lamps in class A are the most efficient at converting electrical into light.

The classification of OSRAM DULUX® lamps is given in the OSRAM Lighting Program.

Global presence.

OSRAM supplies customers in 148 countries.

- 85 companies and sales offices for 122 countries
- 26 countries served by local agents or OSRAM GmbH, Munich

OSRAM associated companies and support centers.

Albania	Latvia
Argentina	Lithuania
Australia	Macedonia
Austria	Malaysia
Belarus	Mexico
Bosnia-Herzegovina	Moldavia
Brazil	Netherlands
Bulgaria	Norway
Canada	Pakistan
Chile	Peru
China	Philippines
Columbia	Poland
Croatia	Portugal
Czech Republic	Romania
Denmark	Russia
Ecuador	Saudi Arabia
Egypt	Serbia
Estonia	Singapore
Finland	Slovakia
France	South Africa
Georgia	Spain
Germany	Sweden
Great Britain	Switzerland
Greece	Taiwan
Hungary	Thailand
India	Tunesia
Indonesia	Turkey
Iran	Ukraine
Italy	United Arab Emirates
Japan	USA
Kazakhstan	Uzbekistan
Kenya	Vietnam
Korea	

OSRAM GmbH

Head Office
Hellabrunner Strasse 1
81543 Munich
Germany
Phone +49 (0) 89-6213-0
Fax +49 (0) 89-6213-20 20
www.osram.com